

rail

design_Perin & Topan

status,
function
& prestige



BRALCO
YOUR SMART ITALIAN OFFICE

rail index

freestanding desk	4
desk with structural cabinet	26
ray desk	50
delta desk	60
meeting table	72
finishes	94
technical info	96



rail

office designed
& manufactured
in Italy

_ Anche Rail, come tutti i prodotti Bralco, è pensato, progettato e prodotto in Italia a garanzia di un'originalità esclusiva che ha reso unico e distintivo il Made in Italy nel mondo.

_ Rail, as all Bralco products, has been designed and produced in Italy, to guarantee the exclusive authenticity which characterises Made in Italy Products as unique and distinctive throughout the world.

_ Rail, comme tous les produits Bralco, est un système conçu, mis au point et fabriqué en Italie en garantie d'une originalité exclusive qui a permis au Made in Italy de se distinguer et de s'affirmer dans le monde.

_ Auch Rail wird - wie alle Produkte von Bralco - in Italien konzipiert, entwickelt und hergestellt. Eine Garantie für einen exklusiven, originellen Charakter, der dafür sorgt, dass "Made in Italy" heute weltweit ein Begriff sowie schlicht und einfach unerreich ist.

_ Net als alle producten van Bralco is Rail in Italië ontworpen en geproduceerd. Het wordt gekenmerkt door een exclusief en origineel Made in Italy design.

_ Rail, al igual que todos los productos Bralco, ha sido concebido, diseñado y fabricado en Italia garantizando una originalidad exclusiva, característica de unicidad y distinción del Made in Italy en el mundo.



rail

creativity,
function
& prestige



_Le linee pure ed essenziali di Rail non impongono nessuna gerarchia sociale, ma comunicano status in virtù di una eleganza formale che appare in tutta la sua forte evidenza.

_Rail's pure and essential features do not establish any social hierarchy: instead, they exude a sense of status through the formal elegance that appears in all its relevance.

_Les lignes pures et essentielles de Rail n'imposent aucune hiérarchie sociale, mais communiquent un statut en vertu d'une élégance formelle qui apparaît dans toute son évidence.

_Die reinen und essentiellen Linien von Rail legen keine soziale Hierarchie auf, kommunizieren jedoch Status, dank einer ausprägenden formalen Eleganz.

_De zuivere en essentiële lijnen van Rail leggen geen sociale hiërarchie op, maar brengen status over op grond van een duidelijke formele elegantie.

_Las líneas puras y esenciales de Rail no imponen ninguna jerarquía social, pero comunican estatus en virtud de una elegancia formal que se manifiesta en toda su fuerte evidencia.



scrivania in vetro · glass desk
bureau en verre · Schreibtisch aus Glas
bureau in glas · escritorio de cristal

240 x 100 x 75 cm
94 1/2" x 39 1/4" x 29 1/2" in

*rovere naturale, vetro trasparente
e acciaio cromato lucido.*

*natural oak wood, clear glass
and polished chrome-plated steel.*

*chêne rouvre naturel, verre transparent
et acier chromé brillant.*

*Eiche natur, transparentes Glas
und Edelstahl blank verchromt.*

*natuureik, transparant glas
en glanzend verchromd staal.*

*roble natural, cristal transparente
y acero cromado brillante.*

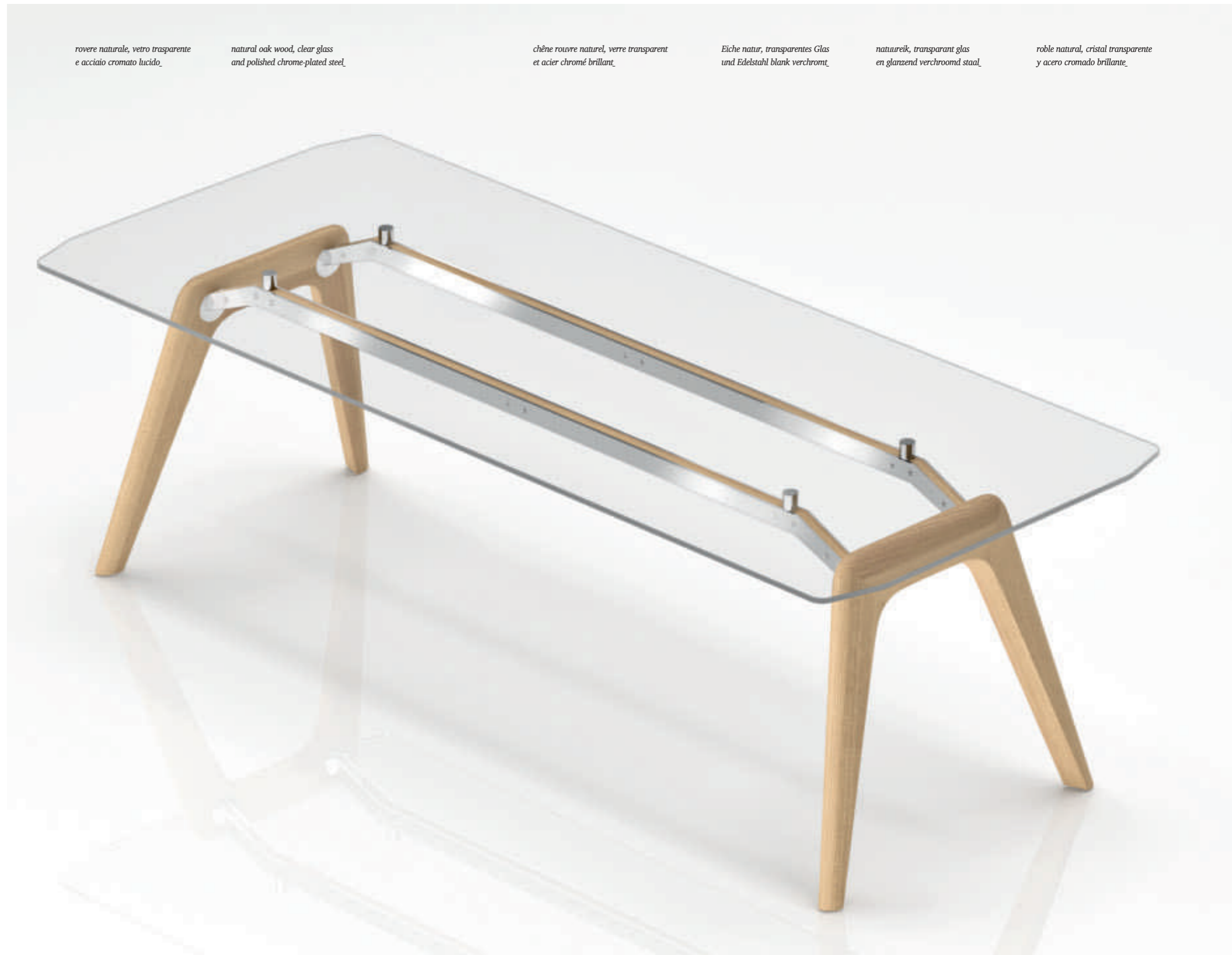

rovere naturale, laccato bianco,
vetroceramica: grigio Stone opaco
e acciaio cromato lucido.

natural oak wood, white veneer,
glass ceramic: Stone grey matt and
polished chrome-plated steel.

chêne rouvre naturel, laqué blanc,
vitreoceramique: gris mat Stone et
acier chromé brillant.

Eiche natur, weiß lackiert,
Glaskeramik: Grau matt Stone und
Edelstahl blank verchromt.

natuureik, gelakt wit,
vitrokeramisch: grijs Stone mat en
glanzend verchromd staal.

roble natural, lacado blanco,
vitreoceramica: gris mate stone y
acero cromado brillante.



rovere bianco, laccato titanio,
vetroceramica: bianco
Calacatta lucido e acciaio
cromato lucido.

white oak wood, titanium-
coloured veneer, glass
ceramic: glossy white
Calacatta and polished
chrome-plated steel.

chêne rouvre blanc, laqué
titane, vitroceramique: blanc
brillant Calacatta
et acier chromé brillant.

Eiche weiß, titan lackiert,
Glaskeramik: Weiß glänzend
Calacatta und Edelstahl blank
verchromt.

witte eik, gelakt titanium,
vitrokeramisch: Glanzend
wit Calacatta en glanzend
verchromd staal.

roble blanco, lacado titanio,
vetroceramica: Calacatta
blanco brillo y acero cromado
brillante.



rovere naturale, laccato bianco,
acciaio laccato nero opaco
e acciaio cromato lucido_

natural oak wood, white veneer,
matt black lacquered steel and
polished chrome-plated steel_

chêne rouvre naturel, laqué
blanc, acier laqué noir mat
et acier chromé brillant_

Eiche natur, weiß lackiert, Edelstahl
mattschwarz lackiert und Edelstahl
blank verchromt_

natuureik, gelakt wit, gelakt
matzwart staal en glanzend
verchromd staal_

roble natural, lacado blanco,
acero lacado negro mate
y acero cromado brillante_



rail

functionality style & color

Il colore entra in ufficio e rende vivo e informale l'ambiente di lavoro. Questa combinazione cromatica è solo un suggerimento: nella gamma delle finiture Rail si possono individuare soluzioni molto personali ed originali.

Colours permeate the office making the working space vibrant and informal. This colour scheme is just a suggestion: using the finishes of the Rail range, we're able to create different customized and original solutions.

La couleur pénètre dans le bureau en rendant le lieu de travail vivant et informel. Cette combinaison chromatique n'est qu'une suggestion : il est possible de trouver des solutions très personnelles et originales dans la gamme de finitions Rail.

Die Farbe dringt im Büro ein und macht das Arbeitsumfeld lebhaft und informell. Diese Farbkombination ist nur ein Vorschlag: In der Auswahl der Rail-Varianten werden zahlreiche persönliche und originale Lösungen angeboten.

Kantoren worden kleurrijk, waardoor de werkomgeving levendiger en informeler wordt. Deze kleurencombinatie is slechts een suggestie: het assortiment afwerkingen van Rail bevat tal van persoonlijke en originele oplossingen.

El color entra en la oficina y anima con un toque informal el ambiente de trabajo. Esta combinación cromática es solo una sugerencia: en la gama de los acabados Rail se pueden definir soluciones altamente personales y originales.

rovere naturale, laccato bordeaux, laccato titanio, acciaio laccato nero opaco e acciaio cromato lucido

natural oak wood, burgundy veneer, titanium-coloured veneer, matt black lacquered steel and polished chrome-plated steel

chêne rouvre naturel, laqué bordeaux, laqué titane, acier laqué noir mat et acier chromé brillant

Eiche natur, bordeauxrot lackiert, titan lackiert, Edelstahl mattschwarz lackiert und Edelstahl blank verchromt

natuureik, gelakt bordeaux, gelakt titanium, gelakt matzwart staal en glanzend verchromd staal

roble natural, lacado burdeos, lacado titanio, acero lacado negro mate y acero cromado brillante



rail

freestanding
desk



rovere tabacco, laccato nebbia
e acciaio cromato lucido

tobacco coloured oak wood, dark
white veneer and polished chrome-
plated steel

chêne rouvre tabac, laqué brume
et acier chromé brillant

Eiche tabak, nebel lackier
und Edelstahl blank verchromt

tabak eik, gelak mist
en glanzend verchroomd staal

roble tabaco, lacado niebla
y acero cromado brillante



rail

formal
elegance

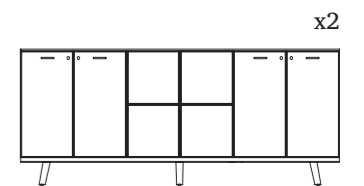

credenza · cabinet · armoire basse
Anrichte · kast · aparador

240 x 40 x 102 cm
94 1/2" x 15 3/4" x 40" in

rovere tabacco, laccato verde muschio,
acciaio laccato nero opaco e acciaio
cromato lucido; piano meeting
in ecopelle titanio e rovere tabacco.

tobacco coloured oak wood, moss green
veneer, matt black lacquered steel and
polished chrome-plated steel; conference
tabletop made of titanium-coloured eco-
leather and tobacco coloured oak wood.

chêne rouvre tabac, laqué vert mousse,
acier laqué noir mat et acier chromé
brillant; plateau pour réunion en cuir
écologique titane et chêne rouvre tabac.

Eiche tabak, moosgrün lackiert, Edelstahl
mattschwarz lackiert und Edelstahl blank
verchrom; Konferenztischplatte aus
Ecopell-Leder und Eiche tabak.

tabakskleurige eik, gelakt mosgroen,
gelakt matzwart staal en glanzend
verchromd staal; vergaderblad in
titanium kunstleer en tabakskleurige eik.

roble tabaco, lacado verde musgo, acero
lacado negro mate y acero cromado
brillante; sobre de mesa de reuniones de
ecopiel titanio y roble tabaco.



rail

composition elements & dimensions

08/09 10/11

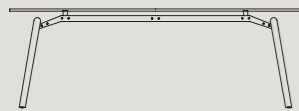

scrivania in vetro · glass desk
bureau en verre · Schreibtisch aus Glas
bureau in glas · escritorio de cristal

L x P x H

220 x 100 x 75 cm
86 3/4" x 39 1/4" x 29 1/2" in

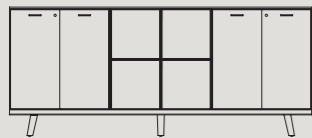

credenza · cabinet · armoire basse
Anrichte · kast · aparador

240 x 40 x 102 cm
94 1/2" x 15 3/4" x 40" in



modulo di servizio vetro · glass service
cabinet · desserte verre · Glas-Modul glazen
component · módulo de servicio cristal

80 x 40 x 75 cm
31 1/2" x 15 3/4" x 29 1/2" in



tavolino da caffè · coffee table
table basse · Kaffeetisch
koffietafelije · mesita de café

120 x 60 x 40 cm
47 1/4" x 23 3/4" x 15 3/4" in

12/13 14/15

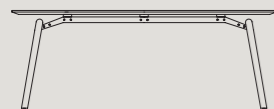

scrivania in legno · wooden desk
bureau en bois · Schreibtisch aus Holz
bureau in hout · escritorio de madera

L x P x H

220 x 100 x 75 cm
200 x 100 x 75 cm
86 3/4" x 39 1/4" x 29 1/2" in
78 3/4" x 39 1/4" x 29 1/2" in



credenza · cabinet · armoire basse
Anrichte · kast · aparador

200 x 40 x 102 cm
78 3/4" x 15 3/4" x 40" in

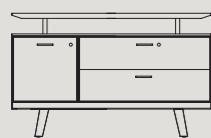

modulo di servizio legno · wooden service
cabinet · desserte bois · Modul aus Holz
houten component · módulo de servicio
madera

120 x 40 x 75 cm
47 1/4" x 15 3/4" x 29 1/2" in

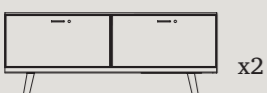

credenza · cabinet · armoire basse
Anrichte · kast · aparador

160 x 40 x 62 cm
63" x 15 3/4" x 24 1/2" in

> 12/13 14/15



tavolo riunione in legno · wooden
conference table · table de réunion en
bois · Konferenztisch aus Holz
vergadertafel in hout · mesa de reuniones
de madera

L x P x H

120 x 120 x 75 cm
47 1/4" x 47 1/4" x 29 1/2" in

18/19

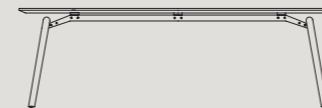

scrivania in legno · wooden desk
bureau en bois · Schreibtisch aus Holz
bureau in hout · escritorio de madera

L x P x H

240 x 100 x 75 cm
94 1/2" x 39 1/4" x 29 1/2" in

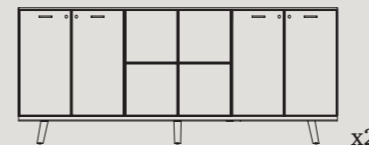

credenza · cabinet · armoire basse
Anrichte · kast · aparador

240 x 40 x 102 cm
94 1/2" x 15 3/4" x 40" in



modulo di servizio legno · wooden service
cabinet · desserte bois · Modul aus Holz
houten component · módulo de servicio
madera

120 x 40 x 75 cm
47 1/4" x 15 3/4" x 29 1/2" in

22/23

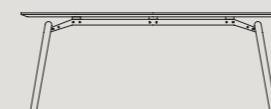

scrivania in legno · wooden desk
bureau en bois · Schreibtisch aus Holz
bureau in hout · escritorio de madera

L x P x H

200 x 100 x 75 cm
78 3/4" x 39 1/4" x 29 1/2" in



credenza · cabinet · armoire basse
Anrichte · kast · aparador

200 x 40 x 102 cm
78 3/4" x 15 3/4" x 40" in



modulo di servizio legno · wooden service
cabinet · desserte bois · Modul aus Holz
houten component · módulo de servicio
madera

80 x 40 x 75 cm
31 1/2" x 15 3/4" x 29 1/2" in



tavolo riunione in legno · wooden
conference table · table de réunion en bois
Konferenztisch aus Holz · vergadertafel in
hout · mesa de reuniones de madera

160 x 160 x 75 cm
63" x 63" x 29 1/2" in

rail

desk with structural
cabinet



rovere naturale, laccato bianco,
vetro trasparente e acciaio
cromato lucido_

natural lacquered oak, white
veneer, clear glass and polished
chrome-plated steel_

chêne rouvre naturel, laqué
blanc, verre transparent et
acier chromé brillant_

Eiche natur, weiß lackiert,
transparentes Glas und Edelstahl
blank verchromt_

natuureik, gelakt wit,
transparent glas en glanzend
verchromd staal_

roble natural, lacado blanco,
cristal transparente y acero
cromado brillante_



rovere bianco, laccato bianco
e acciaio laccato nero opaco;
piano meeting in ecopelle titanio
e rovere bianco_

natural lacquered oak, white veneer
and matt black lacquered steel
conference table made of titanium-
coloured eco-leather and white oak wood_

chêne rouvre blanc, laqué blanc
et acier laqué noir mat ;
plateau pour réunion en cuir écologique
titane et chêne rouvre blanc_

Eiche weiß, weiß lackiert und
Edelstahl mattschwarz lackiert;
Konferenztischplatte aus Ecopell-
Leder titan und Eiche weiß_

wit eiken, gelakt wit, en gelakt
matzwart staal; vergaderblad in
titanium kunstleder en witte eik_

roble blanco, lacado blanco y acero
lacado negro mate; sobre de mesa de
reuniones de ecopiel titanio y roble
blanco_



rail

*rovere naturale, vetro trasparente,
laccato tortora e acciaio cromato
lucido.*

*natural oak wood, clear glass,
dove-grey veneer and polished
chrome-plated steel.*

*chêne rouvre naturel, verre
transparent, laqué gris tourterelle
et acier chromé brillant.*

*Eiche natur, transparentes Glas,
taubengrau lackiert und Edelstahl
blank verchromt.*

*natuureik, transparant glas, gelakt
duifgrijs en glanzend verchromd
staal.*

*roble natural, cristal transparente,
lacado gris ceniciento y acero
cromado brillante.*



rovere tabacco, vetro trasparente,
laccato giallo gold e acciaio
cromato lucido_

tobacco coloured oak wood, clear
glass, gold-yellow veneer and
polished chrome-plated steel_

chêne rouvre tabac, verre
transparent, laqué jaune or et
acier chromé brillant_

Eiche tabak, transparentes Glas,
gold-gelb lackiert und Edelstahl
blank verchromt_

tabakskleurige eik, transparant
glas, gelakt goudgeel en
glanzend verchromd staal_

roble tabaco, cristal
transparente, lacado amarillo
gold y acero cromado brillante_



rail

strong & slight

_Questa immagine mostra lo slancio estetico che caratterizza Rail. Le travi in acciaio cromato lucido e con l'anima in legno a vista, sostengono la trasparente leggerezza del piano in vetro.

_This image shows Rail's aesthetic design. The polished chrome-plated pedestals with the wooden core in view support the clear lightness of the glass top.

_Cette image montre l'élan esthétique caractérisant Rail. Les poutres en acier chromé brillant dont l'âme en bois est apparente supportent la légèreté transparente du plateau en verre.

_Dieses Bild bezeugt den ästhetischen Elan, wodurch Rail gekennzeichnet wird. Die blank verchromte Edelstahlträger und das sichtbare hölzerne Innere unterstützen die transparente Leichtigkeit der gläsernen Tischplatte.

_Deze afbeelding toont de gestroomlijnde elegantie die kenmerkend is voor Rail. De staven in glanzend verchromd staal en het centrale gedeelte in zichtbaar hout ondersteunen de transparante lichtheid van het glazen blad.

_Esta imagen muestra la típica esbeltez estética de Rail. Las vigas de acero cromado brillante con alma de madera a la vista sostienen la transparente ligereza del sobre de cristal.



rovere tabacco, laccato
tortora e vetroceramica:
nero Marquinia opaco_

tobacco oak wood, dove-grey
veneer and glass ceramic:
Marquinia black matt_

chêne rouvre tabac,laqué
tourterelle et vitroceramique:
noir mat Marquinia_

Eiche tabak, taubengrau lackiert
Und glaskeramik: Schwarz
matt Marquinia_

tabakskleurige eik, duifgrijs
gelakt en vitrokeramisch:
zwart Marquinia mat_

roble tabaco,lacado gris
zeniciente y vitroceramica:
Marquina negro mate_



rail

respect of privacy

_In evidenza la naturalità del vero legno e la particolare lavorazione a "diamante" del piano; sottile sul bordo e più spesso verso il centro per suggerire una idea di estrema leggerezza e slancio. Il modesty panel, anch'esso sagomato, offre un alto grado di privacy.

_The naturalness of real wood and the special "diamond" pattern of the top are highlighted in this image; the structure is thinner on the edge and thicker on the centre, to evoke a light and slender feel. The patterned modesty panel offers a high level of privacy.

_La naturalité du bois véritable et le traitement particulier en « diamant » du plateau sont mis en évidence ; mince sur le bord et plus épais vers le centre afin de suggérer une idée de légèreté extrême et d'élan. La voile de fond, elle aussi profilée, offre une grande intimité.

_Bemerkenswert und auffallend ist die Natürlichkeit des authentischen Holzes und die besondere facettierte Bearbeitung der Tischplatte; Dünn am Rand und dicker in der Mitte um extreme Leichtigkeit auszudrücken. Das Modesty Paneel, auch geformt, garantiert ein hohes Maß an Privacy.

_De natuurlijke eigenschappen van het hout staan centraal, alsook de bijzondere "diamant"-achtige afwerking van het blad, dun aan de rand en dikker naar het midden toe, om buitengewone lichtheid en stroomlijning te suggereren. Het knieschot garandeert een hoge vorm van privacy.

_En primer plano la naturalidad de la madera auténtica y la manufactura diamantada del sobre; fino en el canto y más grueso hacia el centro para sugerir una idea de extraordinaria ligereza y estilización. El panel de protección, también perfilado, ofrece un alto nivel de privacidad.



rail

desk with structural
cabinet



rovere nero, laccato titanio, vetro
trasparente e acciaio cromato
lucido_

black oak wood, titanium-coloured
veneer, clear glass and polished
chrome-plated steel_

chêne rouvre noir, laqué titane,
verre transparent et acier chromé
brillant_

Eiche schwarz, titan lackiert,
transparentes Glas und Edelstahl
blank verchromt_

zwarte eik, gelakt titanium,
transparent glas en glanzend
verchromd staal_

roble negro, lacado titanio, cristal
transparente y acero cromado
brillante_



rail

qualities
sharing



rovere nero e laccato titanio_

*black oak wood and titanium-
coloured veneer_*

chêne rouvre noir et laqué titane_

Eiche schwarz und titan lackiert_

zwarte eik en gelakt titanium_

roble negro y lacado titanio_

rail

composition elements & dimensions

28/28 34/35

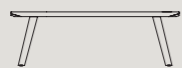
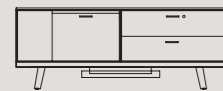
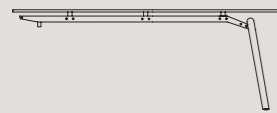

30/31

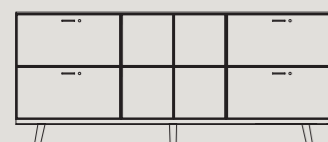
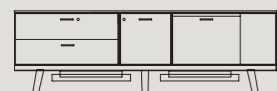
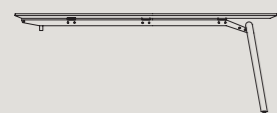

scrivania in vetro · glass desk
bureau en verre · Schreibtisch aus Glas
bureau in glas · escritorio de cristal

modulo di servizio · service cabinet
desserte · Modul · component
módulo de servicio

credenza · cabinet · armoire basse
Anrichte · kast · aparador

tavolo riunione in vetro · glassconference
table · table de réunion en verre
Konferenztisch aus Glas · vergadertafel in
glazen · mesa de reuniones de cristal

tavolino da caffè · coffee table
table basse · Kaffeetisch
koffietafeltje · mesita de café

L x P x H

200 x 100 x 75 cm
78 3/4" x 39 1/4" x 29 1/2" in

160 x 40 x 62 cm
63" x 15 3/4" x 24 1/2" in

200 x 40 x 102 cm
78 3/4" x 15 3/4" x 40" in

160 x 160 x 75 cm
63" x 63" x 29 1/2" in

120 x 60 x 40 cm
47 1/4" x 23 3/4" x 15 3/4" in

L x P x H

200 x 100 x 75 cm
78 3/4" x 39 1/4" x 29 1/2" in

200 x 40 x 62 cm
78 3/4" x 15 3/4" x 24 1/2" in

240 x 40 x 102 cm
94 1/2" x 15 3/4" x 40" in

179 x 172 x 75 cm
70 1/2" x 67 3/4" x 29 1/2" in

tavolo riunione in ecopelle · eco-leather
conference table · table de réunion en cuir
écologique · Konferenztisch aus Ecopell-Leder
vergadertafel in kunstleder · mesa de
reuniones de ecopiel

32/33

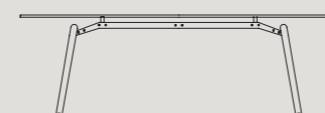
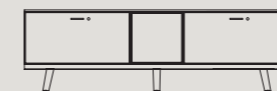
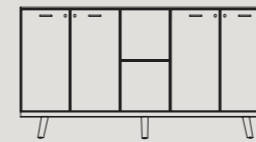
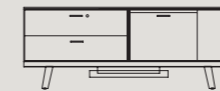
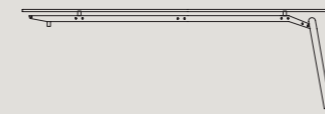

38/39

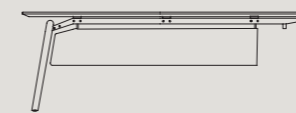

44/45 46/47

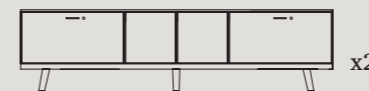
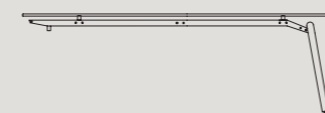

scrivania in vetro · glass desk
bureau en verre · Schreibtisch aus Glas
bureau in glas · escritorio de cristal

modulo di servizio · service cabinet
desserte · Modul · component
módulo de servicio

credenza · cabinet · armoire basse
Anrichte · kast · aparador

credenza · cabinet · armoire basse
Anrichte · kast · aparador

tavolo riunione in vetro · glassconference
table · table de réunion en verre
Konferenztisch aus Glas · vergadertafel in
glazen · mesa de reuniones de cristal

L x P x H

240 x 100 x 75 cm
94 1/2" x 39 1/4" x 29 1/2" in

160 x 40 x 62 cm
63" x 15 3/4" x 24 1/2" in

200 x 40 x 102 cm
78 3/4" x 15 3/4" x 40" in

200 x 40 x 62 cm
78 3/4" x 15 3/4" x 24 1/2" in

240 x 120 x 75 cm
94 1/2" x 47 1/4" x 29 1/2" in

L x P x H

220 x 100 x 75 cm
86 3/4" x 39 1/4" x 29 1/2" in

modulo di servizio · service cabinet
desserte · Modul · component
módulo de servicio

credenza · cabinet · armoire basse
Anrichte · kast · aparador

tavolino da caffè · coffee table
table basse · Kaffeetisch
koffietafeltje · mesita de café

200 x 40 x 62 cm
78 3/4" x 15 3/4" x 24 1/2" in

240 x 40 x 102 cm
94 1/2" x 15 3/4" x 40" in

120 x 60 x 40 cm
47 1/4" x 23 3/4" x 15 3/4" in

L x P x H

240 x 100 x 75 cm
94 1/2" x 39 1/4" x 29 1/2" in

modulo di servizio · service cabinet
desserte · Modul · component
módulo de servicio

credenza · cabinet · armoire basse
Anrichte · kast · aparador

200 x 40 x 62 cm
78 3/4" x 15 3/4" x 24 1/2" in

200 x 40 x 62 cm
78 3/4" x 15 3/4" x 24 1/2" in

rail

ray
desk



rovere grigio, rovere grigio
e laccato bordeaux, laccato
tortora

grey oak wood, grey oak wood
and burgundy veneer, dove-grey
veneer

chêne rouvre gris, chêne rouvre
gris et laqué bordeaux, laqué
gris tourterelle

Eiche grau, Eiche grau
und bordeauxrot lackiert,
taubengrau lackiert

grijze eik, grijze eik en
gelakt bordeaux, gelakt
duifgrijs

roble gris, roble gris y
lacado burdeos, lacado gris
ceniciento

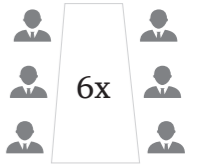

rail

meet, share, communicate

La scrivania direzionale modifica il proprio ruolo adattandosi alle esigenze e permette di svolgere il lavoro individuale, ricevere ed accogliere, condividere e comunicare. Il mobile strutturale è già configurato per il passaggio cavi dal piano scrivania.

The executive desk extends its functions by adapting to reception, sharing and communication needs. The furniture structure is already equipped with a grommet cable hole on the desktop.



Le bureau de direction modifie son propre rôle en s'adaptant à l'exigence consistant à pouvoir recevoir et accueillir, partager et communiquer. Le meuble structural est déjà configuré pour le passage des câbles jusqu'au plateau du bureau.

Der Direktionsschreibtisch ändert die eigene Funktion und richtet sich nach bestimmten Bedürfnissen: Empfangen, teilen und kommunizieren. Der Schrankunterbau ist schon für die Kabeldurchführung zur Schreibtischplatte konfiguriert.

De directietafel wijzigt haar rol door zich aan te passen aan de behoeften om mensen te ontvangen, ervaringen te delen en te communiceren. De meubelstructuur is reeds voorzien voor het doorvoeren van de kabels naar het bureaublad.

El escritorio de dirección modifica su rol para adaptarse a distintas necesidades: recibir y acoger, compartir y comunicar. El mueble estructural está configurado de modo que permite el paso de los cables al sobre del escritorio.

rovere naturale
e laccato tortora

natural oak wood
and dove-grey veneer

chêne rouvre naturel
et laqué gris tourterelle

Eiche natur und
taubengrau lackiert

natuureik
en duifgrijs gelakt

roble natural
y lacado gris ceniciento

Managerial



Managerial
+ 1 - 2 guest

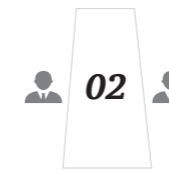

Meeting x3

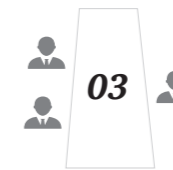

rail shape suggests function

La forma trapezoidale del piano assume un alto valore ergonomico quando, dal lavoro individuale, si desidera passare ad un meeting o al lavoro condiviso. Tutta la superficie è a disposizione e vi è un completo utilizzo dello spazio su tutti e tre i lati.

The trapezoidal shape of the top has a significant ergonomic value, allowing use for individual work or for meetings and shared work. The surface is entirely usable, as well as the space on all three sides.



La forme trapézoïdale du plateau revêt une grande valeur ergonomique quand on souhaite passer du travail individuel à une réunion ou à un travail d'équipe. Toute la surface est disponible et il est possible d'utiliser tout l'espace sur les trois côtés.

Die trapezförmige Tischplatte hat ein hohes Maß an Ergonomie, da es einen Übergang von der Einzelarbeit zu einem Meeting oder zur Gruppenarbeit ermöglicht. Die ganze Oberfläche steht zur Verfügung und die vollständige Nutzung des Raumes ist auf allen drei Seiten ermöglicht.

Het trapeziumvormige blad is ergonomische erg nuttig wanneer u een individuele werkruimte wilt omvormen tot een vergader- of gedeelde ruimte. Het volledige oppervlak kan gebruikt worden; de ruimte kan aan de drie kanten volledig benut worden.

La forma trapezoidal del sobre asume un alto valor ergonómico cuando se desea pasar del trabajo individual a una reunión o al trabajo en equipo. Toda la superficie permanece disponible y el espacio se utiliza completamente en los tres lados.

rovere tabacco, laccato titanio, vetro trasparente e acciaio cromato lucido

tobacco coloured oak wood, titanium coloured veneer, clear glass and polished chrome-plated steel

chêne rouvre tabac, laqué titane, verre transparent et acier chromé brillant

Eiche tabak, titan lackiert, transparentes Glas und Edelstahl blank verchromt

tabakskleurige eik, gelakt titanium, transparant glas en glanzend verchromd staal

roble tabaco, lacado titanio, cristal transparente y acero cromado brillante

Managerial



Managerial + 1 - 2 guest

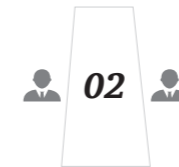

Meeting x3

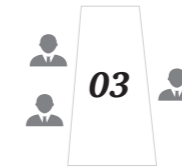

Meeting x6

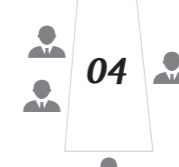

rail

composition elements & dimensions

52/53

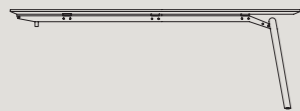

scrivania in legno · wooden desk
bureau en bois · holz-schreibtische
houten bureaus · escritorio de madera

L x P x H

220 x 110 x 75 cm
86 3/4" x 43 1/4" x 29 1/2" in

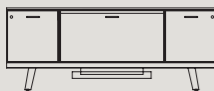

modulo di servizio · service cabinet
desserte · Modul · component
módulo de servicio

160 x 40 x 62 cm
63" x 15 3/4" x 24 1/2" in

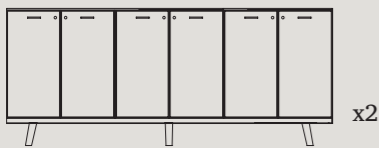

credenza · cabinet · armoire basse
Anrichte · kast · aparador

240 x 40 x 102 cm
94 1/2" x 15 3/4" x 40" in

54/55

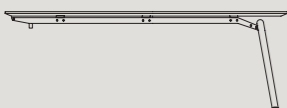

scrivania in legno · wooden desk
bureau en bois · holz-schreibtische
houten bureaus · escritorio de madera

L x P x H

220 x 110 x 75 cm
86 3/4" x 43 1/4" x 29 1/2" in

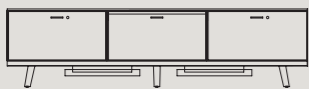

modulo di servizio · service cabinet
desserte · Modul · component
módulo de servicio

240 x 40 x 62 cm
94 1/2" x 15 3/4" x 24 1/2" in

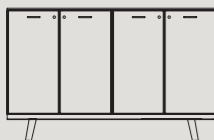

credenza · cabinet · armoire basse
Anrichte · kast · aparador

160 x 40 x 102 cm
63" x 15 3/4" x 40" in

56/57

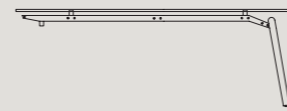

scrivania in vetro · glass desk
bureau en verre · Schreibtisch aus Glas
bureau in glas · escritorio de cristal

L x P x H

220 x 110 x 75 cm
86 3/4" x 43 1/4" x 29 1/2" in

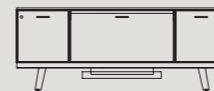

modulo di servizio · service cabinet
desserte · Modul · component
módulo de servicio

160 x 40 x 62 cm
63" x 15 3/4" x 24 1/2" in

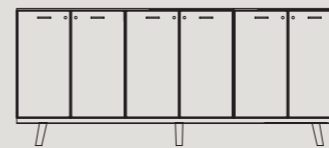

credenza · cabinet · armoire basse
Anrichte · kast · aparador

240 x 40 x 102 cm
94 1/2" x 15 3/4" x 40" in

rail

delta
desk

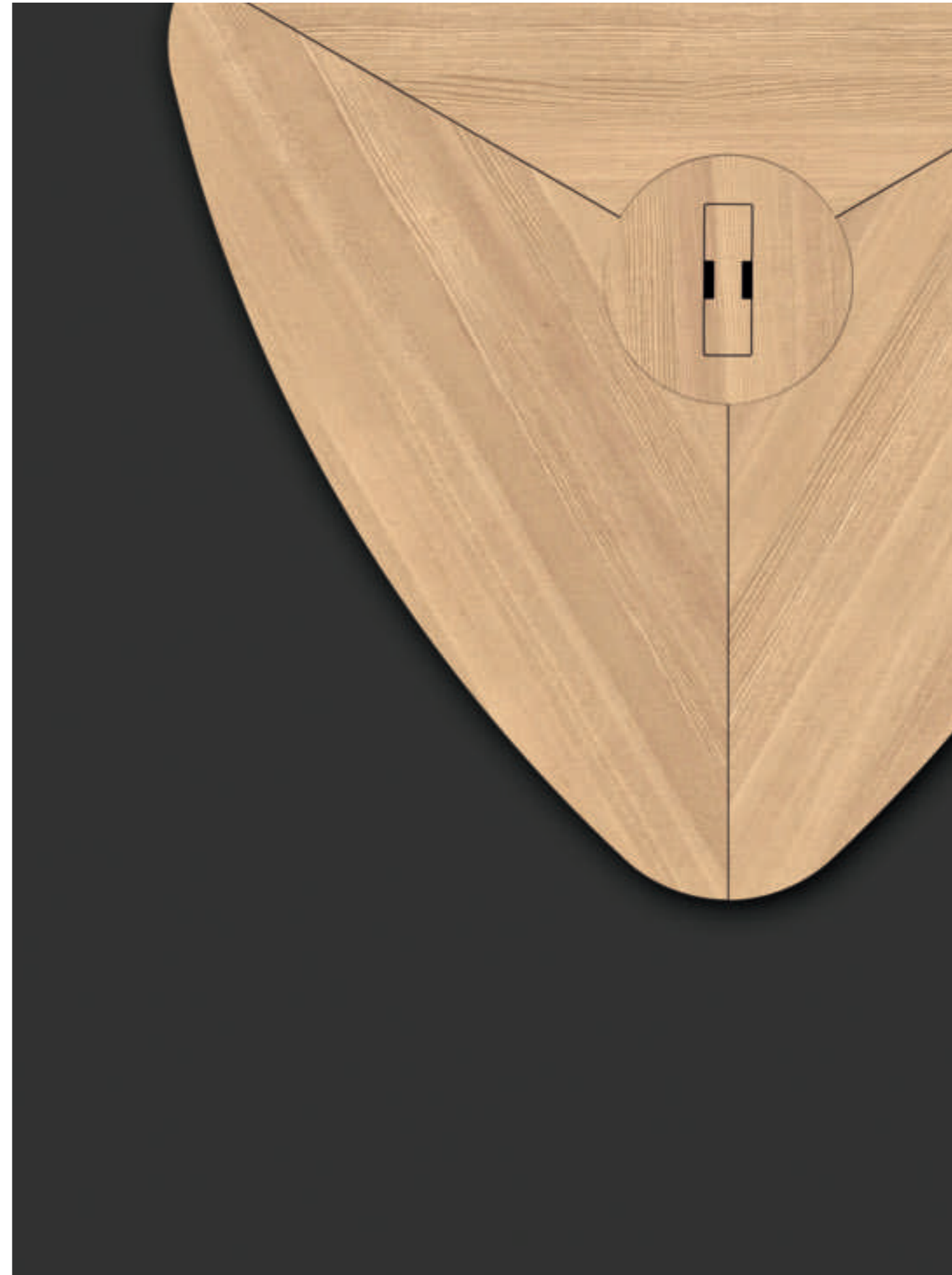

one desk four different uses

«L'organizzazione dello spazio, anche all'interno dell'ufficio direzionale, risponde a logiche di ottimizzazione e razionalizzazione facendo assumere, agli arredi, ruoli polivalenti. Anche in questo caso Rail si rivela innovativo perché, oltre a proporre una forma davvero funzionale, permette di utilizzare il piano sia come scrivania direzionale, oppure come tavolo meeting.

«The organization of space, even within the executive office, responds to optimization and rationalization logics, making the furniture more versatile. Even in this case, Rail is truly innovative, because, apart from featuring a highly functional shape, it allows to use the top as executive desk or as conference table.

«L'organisation de l'espace, même à l'intérieur du bureau de direction, répond à des logiques d'optimisation et de rationalisation en permettant aux meubles d'avoir des rôles polyvalents. Dans ce cas-là aussi, Rail s'avère innovant car, non seulement il propose une forme vraiment fonctionnelle, mais il permet également d'utiliser le plateau tant comme bureau de direction que comme table de réunion.

«Die Raumgestaltung, auch im Chefbüro, entspricht Rationalisierungs- und Optimierungsregeln und die Einrichtungen übernehmen vielfältige Funktionen. Auch in diesem Fall stellt sich Rail innovativ heraus, da es nicht nur eine extrem funktionelle Form darbietet, sondern auch ermöglicht, die Tischplatte als Direktionsschreibtisch oder auch als Konferenztisch zu benutzen.

«Ook in een directiekantoor dient de ruimtelijke organisatie voortdurende geoptimaliseerd te worden en zo rationeel mogelijk georganiseerd te worden. Hierdoor neemt het meubilair een polyvalente rol aan. Ook in dit geval blijkt Rail vernieuwend te zijn. Dankzij de uiterst functionele vorm van het blad kan de tafel zowel als directietafel als vergadertafel gebruikt worden.

«La organización del espacio responde a lógicas de optimización y racionalización que hacen que el mobiliario asuma roles polivalentes incluso en la oficina de dirección. También en este caso Rail demuestra un carácter innovador puesto que, además de proponer una forma realmente funcional, permite utilizar el sobre como escritorio de dirección o como mesa de reuniones.

«Le illustrazioni chiariscono, in modo efficace, la varietà di utilizzo del piano: da scrivania direzionale diventa perfetta per accogliere più ospiti, distribuendoli lungo il perimetro e mantenendo i ruoli, oppure prestandosi a un utilizzo intensivo come piano meeting. «The images efficiently highlight the versatility of the top: from executive desk, it becomes a perfect table to accommodate several guests, by distributing them along the perimeter and maintaining the main hierarchical organization, or by becoming a perfect conference table. «Les illustrations montrent de façon efficace la variété d'utilisation du plateau : de bureau de direction il devient parfait pour accueillir plusieurs personnes, en les distribuant le long de son périmètre et en conservant les rôles, ou bien en se prêtant à une utilisation intensive comme plateau de réunion. «Die Bilder stellen die Vielfältigkeit der Tischplatte wirkungsvoll dar: Optimal als Direktionsschreibtisch, um mehrere Besucher zu empfangen, die in der gesamten Länge sitzen können und gleichzeitig jeweils die eigene Funktion aufrechterhalten, oder als Konferenztisch. «De illustraties tonen op doeltreffende wijze de gebruiksverscheidenheid van het blad: een directietafel wordt omgevormd tot de perfecte omgeving om meerdere personen te ontvangen en ze naast elkaar in de lengte van de tafel te laten plaatsnemen en toch de functies te behouden, of verleent zich tot intensief gebruik als vergadertafel. «Las ilustraciones aclaran eficazmente la variedad de uso del sobre: de escritorio de dirección se convierte en un elemento perfecto para acoger a varios invitados, distribuyéndolos a lo largo del perímetro y manteniendo los roles, o para un uso intensivo como mesa de reuniones.

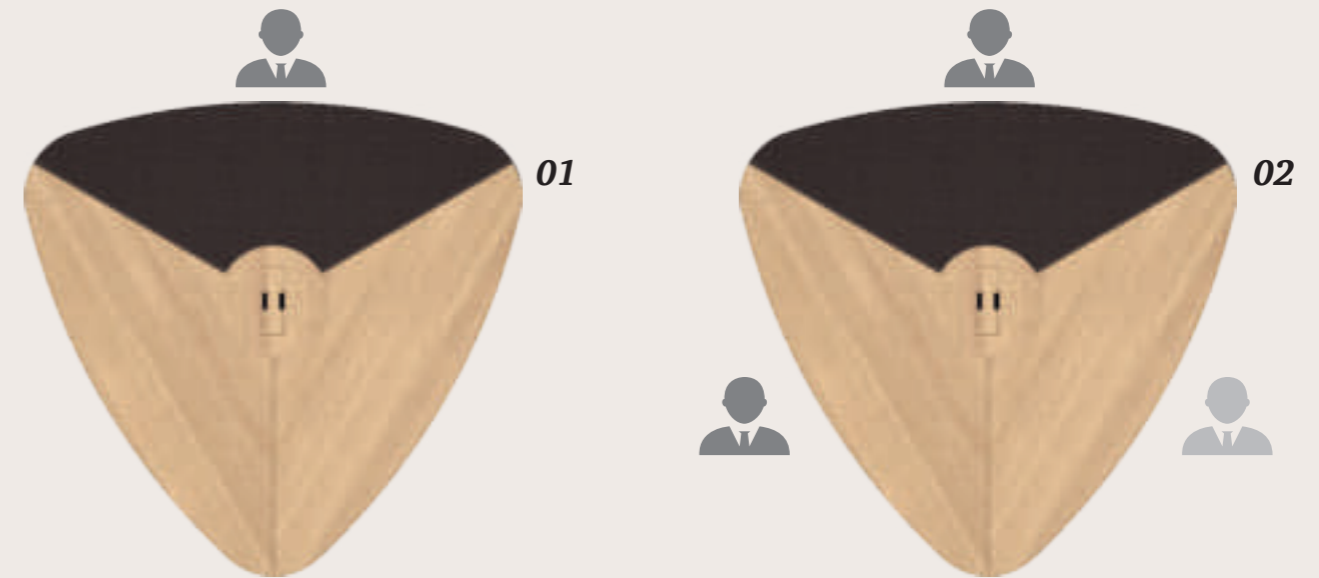

01 Managerial

02 Managerial + 1 - 2 guest

03 Meeting x3

04 Meeting x6

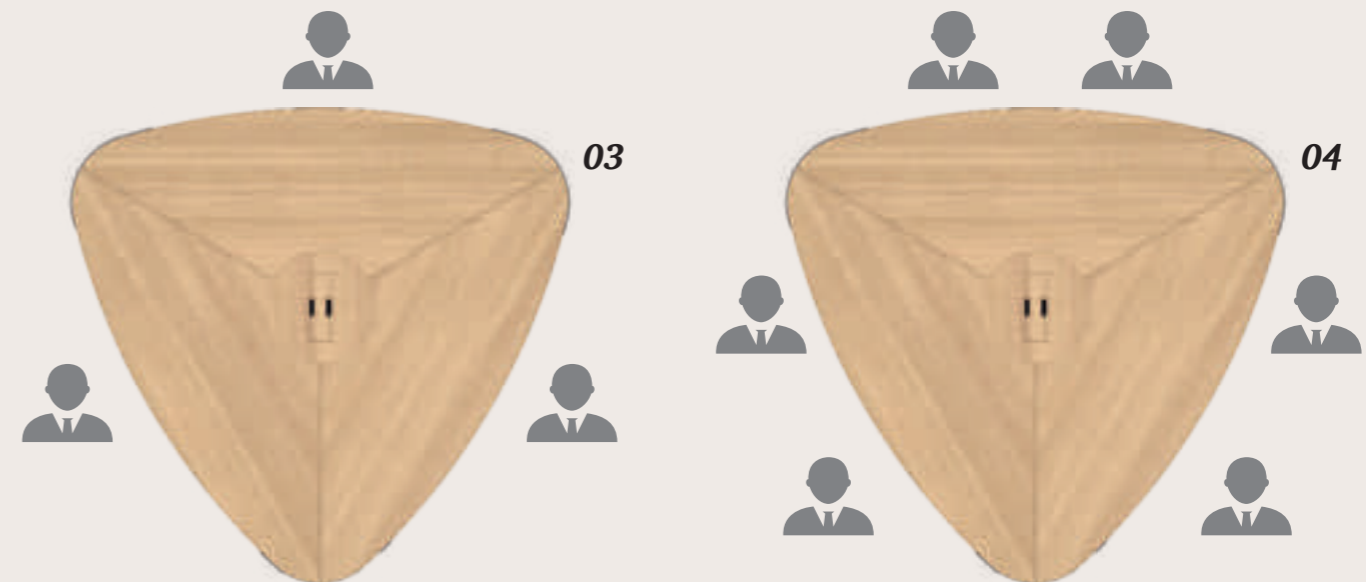

rail relationship

„In ufficio compaiono nuove forme che uniscono alla funzionalità, una ergonomia d'uso assolutamente innovativa. La forma del piano permette di svolgere diverse funzioni, dal lavoro manageriale al lavoro condiviso, sottolineando sempre i ruoli, grazie a uno studio spaziale attento alle relazioni e alle interazioni tra le persone.

„New shapes appear in the office, combining an innovative comfort of use to their functionality. A careful study of the spaces allows to maintain relationships and interactions, underlining the importance of the various roles.

„De nouvelles formes apparaissent au bureau et elles allient à la fonctionnalité une ergonomie d'utilisation totalement innovante. Une étude attentive des espaces permet de maintenir les rapports de relation et d'interaction sans oublier l'importance des rôles.

„Im Büro erscheinen neue Formen, die Funktionalität und eine völlig innovative Ergonomie verbinden. Eine genaue Raumplanung ermöglicht, Verhältnisse und Interaktion aufrecht zu erhalten, aber ohne die Wichtigkeit der einzelnen Rollen zu vergessen.

„In het kantoor verschijnen nieuwe vormen die functionaliteit combineren met een innoverende ergonomie. Een aandachtige bestudering van de ruimte maken gesprekken mogelijk zonder het belang van de rollen te vergeten.

„En la oficina aparecen nuevas formas que aúnan funcionalidad y una ergonomía de uso absolutamente innovadora. Un atento estudio de los espacios permite mantener las relaciones y la interacción personal sin olvidar la importancia de los roles.

rovere bianco, piano
parzialmente rivestito
in ecopelle titanio_

white oak wood, top
partially upholstered with
titanium-coloured eco-leather_

chêne rouvre blanc,
plateau partiellement habillé
en cuir écologique titane_

Eiche weiß, Tischplatte
zum Teil mit Ecopell-leder
titan überzogen_

witte eik, blad gedeeltelijk
bekleed met titaniumkleurig
kunstleder

roble blanco, sobre
parcialmente revestido
en ecopiel titanio_



rail

personal
signature

*rovere naturale,
laccato deep teal*

*natural oak wood,
deep teal veneer*

*chêne rouvre naturel,
laqué bleu-vert foncé*

*Eiche natur,
deep teal lackiert*

*natureik,
gelakt deep teal*

*roble natural,
lacado deep teal*



rail meeting spaces

_Se la forma suggerisce la funzione, Rail presta le proprie linee a performances che rendono l'ufficio estremamente dinamico e flessibile.

_If form is the "how of the matter", Rail's features foster performances that make the office extremely dynamic and flexible.

_Si la forme suggère la fonction, Rail prête ses lignes à des performances qui rendent le bureau extrêmement dynamique et flexible.

_Jede Form deutet eine Funktion an und Rail garantiert immer mit ihren Linien Leistungen, die das Büro extrem dynamisch und flexibel machen.

_De vorm suggereert de functie. De lijnen van Rail zorgen voor een uiterst dynamisch en flexibel kantoor.

_Si la forma sugiere la función, no cabe duda de que Rail ofrece sus líneas a prestaciones que convierten a la oficina en un lugar extraordinariamente dinámico y flexible.

*rovere bianco
ed ecopelle titanio_*

*white oak wood
and titanium-coloured
eco-leather_*

*chêne rouvre blanc
et cuir écologique titane_*

*Eiche weiß
und Ecopell-Leder titan_*

*witte eik
en titaniumkleurig
kunstleder_*

*roble blanco
y ecopiel titanio_*



rail

desk or meeting?

_Quattro sono le configurazioni possibili: piano in vetro trasparente e struttura in una delle 5 diverse essenze in combinazione con l'acciaio cromato lucido, oppure con piano tutto legno, legno ed ecopelle in tre finiture o tutto ecopelle, sempre in tre nuance. Nelle versioni con piano legno o misto oppure tuttopelle, la struttura è sempre disponibile nelle cinque essenze abbinata all'acciaio laccato nero opaco.

_Four possible layouts: clear glass top and structure made of one of the five possible materials, combined with polished chrome-plated steel, or wooden top, wooden and eco-leather top with three different finishes or eco-leather top with three different nuances. In the wooden, mixed or leather top versions, the structure is available in five different materials, combined with matt black lacquered steel.

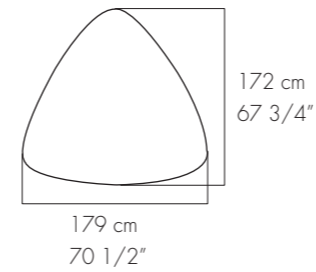

_Quatre configurations sont possibles : plateau en verre transparent et structure dans l'une des cinq différentes essences en combinaison avec l'acier chromé brillant, ou bien avec un plateau entièrement en bois, bois et cuir écologique dans trois finitions ou entièrement en cuir écologique, toujours dans trois nuances. Dans les versions avec un plateau en bois, mixte ou bien entièrement en cuir, la structure est toujours disponible dans les cinq essences associées à l'acier laqué noir mat.

_Er zijn vier configuraties beschikbaar: blad in transparant glas en structuur in een van de vijf verschillende combinaties met glanzend verchromd staal, of met het blad volledig in hout, hout en kunstleder in drie afwerkingen of volledig in kunstleder in drie afwerkingen. In de versies met een blad in hout, hout en leder of volledig in leder is de structuur altijd beschikbaar in de vijf kleuren, gecombineerd met matzwart gelakt staal.

_Es gibt vier mögliche Ausführungen: Tischplatte aus transparentem Glas und Struktur aus einer der fünf verschiedenen Holzarten kombiniert mit Edelstahl blank verchromt, oder mit Tischplatte komplett aus Holz, Holz und Ecopell-Leder in drei Varianten oder komplett aus Ecopell-Leder, immer in drei Nuancen. In den Ausführungen mit Tischplatte aus Holz oder kombiniert oder komplett aus Leder, ist die Struktur immer in den fünf Holztypen verfügbar, kombiniert mit Edelstahl mattschwarz lackiert.

_Las configuraciones posibles son cuatro: sobre de cristal transparente y estructura en una de las cinco distintas maderas en combinación con el acero cromado brillante, o bien con sobre completamente de madera, madera y ecopiel en tres acabados o todo ecopiel, siempre en tres tonalidades. En las versiones con sobre de madera, mixto o completamente de piel, la estructura está siempre disponible en las cinco maderas combinadas con el acero lacado negro mate.



vetro trasparente_
clear glass_
verre transparent_
transparentes Glas_
transparent glas_
cristal transparente_



tuttolegno_
wood_
entièrement en bois_
ganz aus Holz_
volledig hout_
todo madera_



legno ed ecopelle_
wood and eco-leather_
bois et cuir écologique_
Holz und Ecopell-Leder_
hout en kunstleder_
madera y ecopiel_



tutto ecopelle_
eco-leather_
entièrement en cuir écologique_
ganz aus Ecopell-Leder_
volledig kunstleder_
todo ecopiel_

rail

meeting
table

rovere tabacco, vetro
trasparente e acciaio
cromato lucido_

tobacco- coloured oak
wood, clear glass and
polished chrome-plated
steel_

chêne rouvre tabac,
verre transparent et
acier chromé brillant_

Eiche tabak,
transparentes Glas
und Edelstahl blank
verchromt_

tabakskleurige eik,
transparent glas en
glanzend verchromd
staal_

roble tabaco, cristal
transparente y acero
cromado brillante_

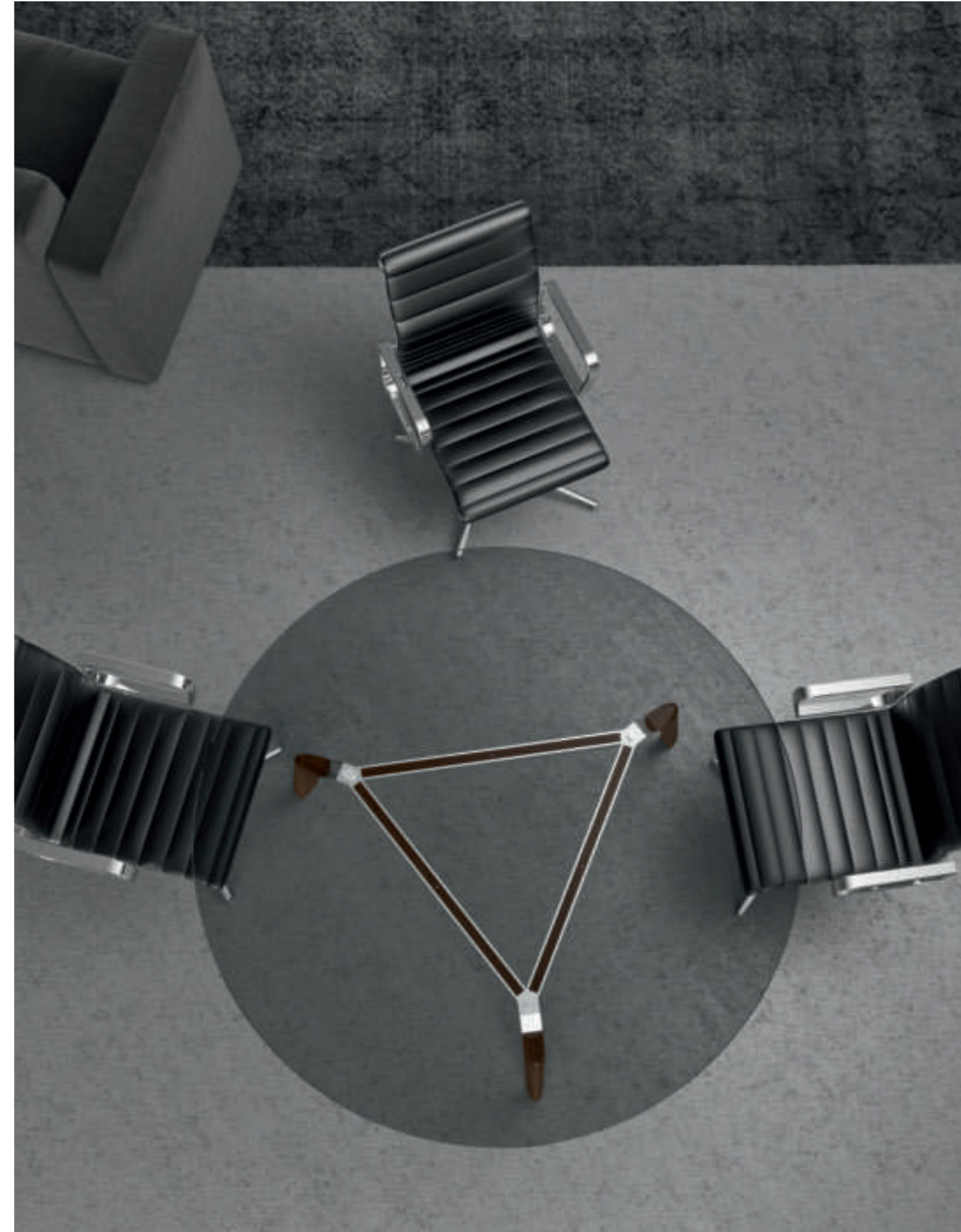

rovere naturale
e laccato bianco

natural oak wood
and white veneer

chêne rouvre naturel
et laqué blanc

Eiche natur
und weiß lackiert

natuureik en wit
gelakt

roble natural
y lacado blanco

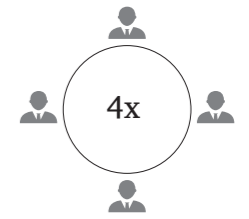

tavolo riunione · conference table
table de réunion · Konferenztisch
vergadertafel · mesa de reuniones

120 x 120 x 75 cm
47 1/4" x 47 1/4" x 29 1/2" in

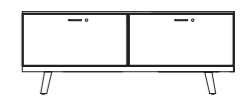

credenza · cabinet · armoire basse
Anrichte · kast · aparador

160 x 40 x 62 cm
63" x 15 3/4" x 24 1/2" in



*rovere naturale, vetro trasparente,
laccato tortora e acciaio cromato
lucido.*

*natural oak wood, clear glass, dove-
grey veneer and polished chrome-plated
steel.*

*chêne rouvre naturel, verre transparent,
laqué gris tourterelle et acier chromé
brillant.*

*Eiche natur, transparentes Glas,
taubengrau lackiert und Edelstahl
blank verchromt.*

*natuureik, transparant glas, duifgrijs
gelakt en glanzend verchromd staal.*

*roble natural, cristal transparente,
lacado gris ceniciento y acero cromado
brillante.*

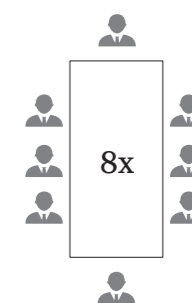

tavolo riunione · conference table
table de réunion · Konferenztisch
vergadertafel · mesa de reuniones

240 x 120 x 75 cm
94 1/2" x 47 1/4" x 29 1/2" in

rovere naturale
e laccato oceano_

natural oak wood
and ocean-blue veneer_

chêne rouvre naturel
et laqué océan_

Eiche natur
und ozean lackiert_

natuureik en
oceaankleurig gelakt_

roble natural
y lacado océano_

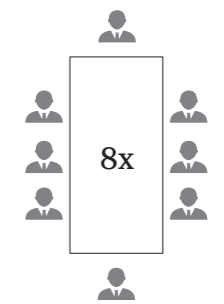

tavolo riunione · conference table
table de réunion · Konferenztisch
vergadertafel · mesa de reuniones

240 x 120 x 75 cm
94 1/2" x 47 1/4" x 29 1/2" in

rovere tabacco
e laccato nebbia

tobacco coloured oak wood
and dark white veneer

chêne rouvre tabac
et laqué brume

Eiche tabak
und nebel lackiert

tabakskleurige eik
en mistkleurig gelakt

roble tabaco
y lacado niebla



rail

composition elements & dimensions

73



tavolo riunione in vetro · glassconference table · table de réunion en verre
Konferenz Tisch aus Glas · vergadertafel in glazen · mesa de reuniones de cristal

L x P x H

160 x 160 x 75 cm
63" x 63" x 29 1/2" in

76/77

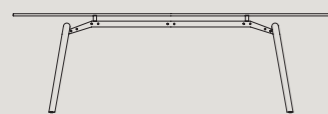

tavolo riunione in vetro · glassconference table · table de réunion en verre
Konferenz Tisch aus Glas · vergadertafel in glazen · mesa de reuniones de cristal

L x P x H

240 x 120 x 75 cm
94 1/2" x 47 1/4" x 29 1/2" in

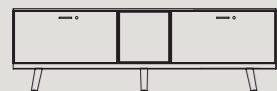

credenza · cabinet · armoire basse
Anrichte · kast · aparador

200 x 40 x 62 cm
78 3/4" x 15 3/4" x 24 1/2" in

78/79

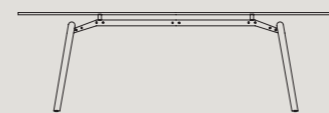

tavolo riunione in legno · woodconference table · table de réunion en bois
Konferenz Tisch aus Holz · vergadertafel in hout · mesa de reuniones de madera

L x P x H

240 x 120 x 75 cm
94 1/2" x 47 1/4" x 29 1/2" in



credenza · cabinet · armoire basse
Anrichte · kast · aparador

240 x 40 x 62 cm
94 1/2" x 15 3/4" x 24 1/2" in

80/81

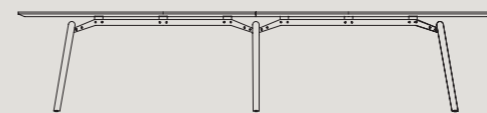

tavolo riunione in legno · wooden conference table · table de réunion en bois · Konferenz Tisch aus Holz
vergadertafel in hout · mesa de reuniones de madera

L x P x H

360 x 120 x 75 cm
141 3/4" x 47 1/4" x 29 1/2" in



credenza · cabinet · armoire basse
Anrichte · kast · aparador

200 x 40 x 62 cm
78 3/4" x 15 3/4" x 24 1/2" in

rail

choose your style

_Rail offre una ampia opportunità di personalizzazione con numerose opzioni cromatiche; le cinque proposte di gambe in essenza sono combinabili con piani nella medesima finitura o in vetro trasparente.

_Rail offers several customization options and colours; the five leg options can be combined with tops with the same finish or clear glass tops.

_Rail offre une grande possibilité de personnalisation avec de nombreuses options chromatiques ; les cinq propositions de piétements en essence peuvent être combinées avec des plateaux dans la même finition ou en verre transparent.

_Rail bietet umfangreiche Personalisierungsmöglichkeiten und zahlreiche Farbkombinationen an; Die hölzernen Beine in fünf Varianten sind mit Tischplatte in designgleicher Gestaltung oder aus transparentem Glas kombinierbar.

_Rail biedt een uitgebreide mogelijkheid om de meubels te personaliseren met talrijke kleuren; de vijf verschillende poten kunnen gecombineerd worden met bladen met dezelfde afwerking of in transparant glas.

_Rail ofrece una amplia posibilidad de personalización con numerosas opciones cromáticas; las cinco propuestas de patas de madera pueden combinarse con sobres con el mismo acabado o de cristal transparente.



*rovere naturale_
natural oak wood_
chêne rouvre naturel_
Eiche natur_
natuureik_
roble natural_*

*rovere grigio_
grey oak wood_
chêne rouvre gris_
Eiche grau_
grijze eik_
roble gris_*

*rovere tabacco_
tobacco coloured
oak wood_
chêne rouvre tabac_
Eiche tabak_
tabakskleurige eik_
roble tabaco_*

*rovere nero_
black oak wood_
chêne rouvre noir_
Eiche schwarz_
zwarte eik_
roble negro_*

*rovere bianco_
white oak wood_
chêne rouvre blanc_
Eiche weiß_
witte eik_
roble blanco_*

rail

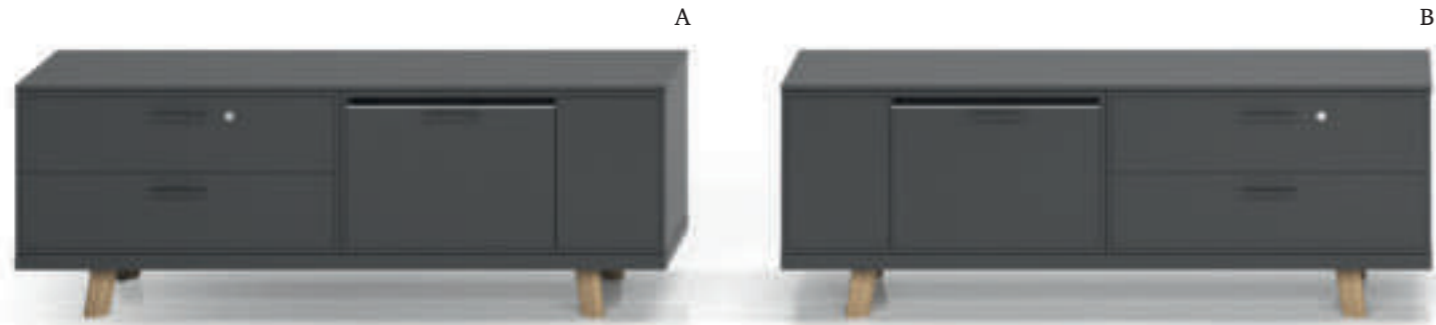

A

B



C



D

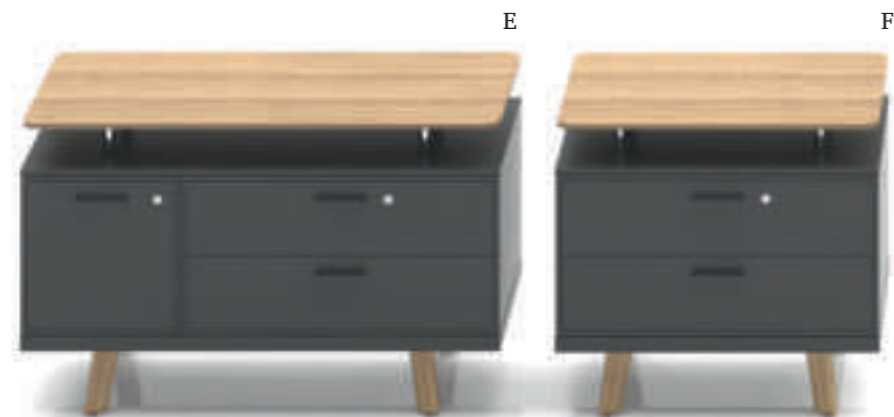

E

F



G

A_ 160 x 40 x 62 cm
63" x 15 3/4" x 24 1/2" in

B_ 160 x 40 x 62 cm
63" x 15 3/4" x 24 1/2" in

C_ 200 x 40 x 62 cm
78 3/4" x 15 3/4" x 24 1/2" in

D_ 200 x 40 x 62 cm
78 3/4" x 15 3/4" x 24 1/2" in

E_ 120 x 40 x 75 cm
47 1/4" x 15 3/4" x 29 1/2" in

F_ 80 x 40 x 75 cm
31 1/2" x 15 3/4" x 29 1/2" in

G_ 160 x 40 x 62 cm
63" x 15 3/4" x 24 1/2" in

H_ 120 x 40 x 75 cm
47 1/4" x 15 3/4" x 29 1/2" in



H

rail

I 240 x 40 x 102 cm
94 1/2" x 15 3/4" x 40" in
L 160 x 40 x 102 cm
63" x 15 3/4" x 40" in
M 200 x 40 x 102 cm
78 3/4" x 15 3/4" x 40" in
N 160 x 40 x 102 cm
63" x 15 3/4" x 40" in
O 240 x 40 x 102 cm
94 1/2" x 15 3/4" x 40" in

P 160 x 40 x 102 cm
63" x 15 3/4" x 40" in
Q 200 x 40 x 102 cm
78 3/4" x 15 3/4" x 40" in
R 240 x 40 x 102 cm
94 1/2" x 15 3/4" x 40" in
S 200 x 40 x 102 cm
78 3/4" x 15 3/4" x 40" in



rail

! *Le immagini delle pagine precedenti servono unicamente a rappresentare alcune possibilità dimensionali della gamma Rail. Per un approfondimento su misure, finiture e combinazioni cromatiche, si suggerisce di consultare il listino. The images featured in the previous pages merely suggest some of the several size options of the Rail range. For more information on sizes, finishes and colour schemes, see the price list. Les images des pages précédentes ne servent qu'à représenter certaines possibilités de dimensions de la gamme Rail. Pour approfondir les mesures, les finitions et les combinaisons chromatiques, il est conseillé de consulter le catalogue. Die Bilder dienen ausschließlich dazu, einige Lösungen und Abmessungen der Serie Rail darzustellen. Um ausführlich im Thema Abmessungen einzugehen, schlagen Sie bitte in der Preisliste nach. De afbeeldingen op de vorige pagina's dienen uitsluitend om een aantal mogelijke afmetingen van het assortiment Rail te illustreren. Voor meer details met betrekking tot afmetingen, afwerkingen en kleurcombinaties, zie de lijst. Las imágenes de las páginas anteriores sirven únicamente para representar algunas posibilidades dimensionales de la gama Rail. Para conocer las medidas exactas, los acabados y las combinaciones cromáticas, es aconsejable consultar la tarifa.*



- T_240 x 40 x 62 cm
94 1/2" x 15 3/4" x 24 1/2" in
- U_160 x 40 x 62 cm
63" x 15 3/4" x 24 1/2" in
- V_240 x 40 x 62 cm
94 1/2" x 15 3/4" x 24 1/2" in
- W_200 x 40 x 62 cm
78 3/4" x 15 3/4" x 24 1/2" in
- Z_240 x 40 x 62 cm
94 1/2" x 15 3/4" x 24 1/2" in



rail electrification system

_I cavi sono resi disponibili su piano attraverso fori con sistema passacavi.
_Cables are available on the top through cable grommet holes.
_Les câbles arrivent sur le plateau à travers des trous avec un système passe-câbles.
_Die Kabel stehen durch das Kabeldurchlasssystem auf der Tischplatte zur Verfügung.
_De kabels worden beschikbaar gemaakt op het blad door speciale kabeldoorvoeringen.
_Los cables resultan disponibles en el sobre gracias a unos orificios con sistema pasacables.

_Lo spazio permette il passaggio dei cavi ad anta chiusa. La pressione esercitata dalle spazzole tiene in posizione i cavi.
_The recess allows the passage of cables even with the door closed. The pressure exerted by the brushes maintains the cables in position.
_L'espace permet le passage des câbles quand la porte est fermée. La pression exercée par les brosses maintient les câbles à leur emplacement.
_Der ausreichende Raum ermöglicht die Kabeldurchführung bei geschlossener Tür. Der von den Bürsten ausgeübte Druck hält die Kabel in Position.
_Het is mogelijk om de kabels erdoor te steken met een gesloten deur. De druk die door de borstels wordt uitgevoerd houdt de kabels op hun plaats.
_El espacio permite el paso de los cables con la puerta cerrada. La presión ejercida por los cepillos mantiene los cables en su posición.

_I cavi sono alloggiati in un'ampia vaschetta e possono essere bloccati con fascette che si inseriscono in apposite fessure.
_The cables are collected in a wide tray and can be locked with clamps inserted in special slots.
_Les câbles sont logés dans un grand bac et peuvent être bloqués avec des colliers qui s'insèrent dans des fentes prévues à cet effet.
_Die Kabel sind in einem großen Behälter enthalten und können durch Klemmen, durch vorgesehene Schlitz, blockiert werden.
_De kabels worden ondergebracht in een ruime mand en kunnen geblokkeerd worden met behulp van klemmen die in de desbetreffende openingen worden gestoken.
_Los cables están alojados en una amplia bandeja y pueden bloquearse con bridas, que se introducen en unas ranuras.

_I cavi transitano in spazi ricavati all'interno del mobile.
_Cables pass through the recesses within the piece of furniture.
_Les câbles transitent dans des espaces situés à l'intérieur du meuble.
_Die Kabel werden innerhalb des Schrankes geführt.
_De kabels worden door ruimten aan de binnenkant van het meubel gestoken.
_Los cables se extienden a lo largo de los espacios obtenidos en el interior del mueble.

_I cavi, dalle prese, vengono raccolti sotto il mobile in un cestello dedicato.
_The cables are collected underneath the piece of furniture in a special tray.
_À partir des prises, les câbles sont rassemblés sous le meuble dans un panier prévu pour cela.
_Die Kabel werden von den Steckdosen unter dem Möbel in einem geeigneten Korb positioniert.
_De kabels worden vanaf de stopcontacten onder het meubel in een speciale mand verzameld.
_Los cables de las tomas de corriente se recogen debajo del mueble en una cesta.

rail

legni

woods · bois · holz · hout · madera

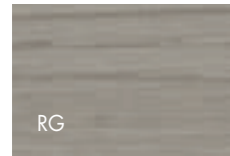

rovere grigio
grey oak
chêne gris
Eiche grau
grijs eiken
roble gris



rovere laccato nero
black lacquered oak
chêne laqué noir
schwarz lackierter Eiche
zwart gelakt eiken
roble lacado negro

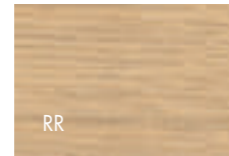

rovere naturale
natural oak
chêne naturel
Natur Eiche
eikenhout natuur
roble natural

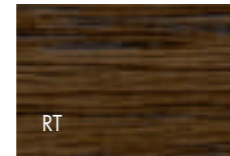

rovere tabacco
tobacco oak
chêne tabac
Eiche Tabak
eikenhout tabak
roble tabaco

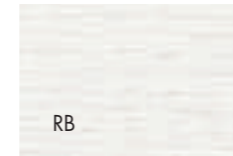

rovere laccato bianco
white lacquered oak
chêne laqué blanc
weiß lackierter Eiche
wit gelakt eiken
roble lacado blanco

laccati

lacquered · laqués · Lackiertes · gelakt · laqueado

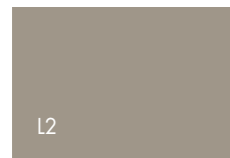

tortora
turtledove
tourterelle
taubengrau
tortelduif
törtola

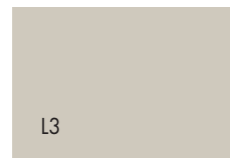

nebbia
mist
brouillard
nebelgrau
mist
niebla

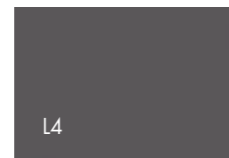

titanio
titanium
litane
Titan
titanium
titanio

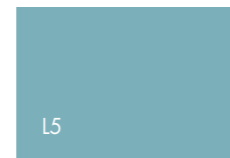

oceano
ocean
océan
Meerblau
ocean
océano

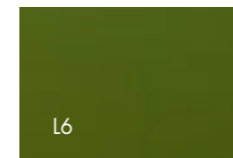

verde muschio
moss green
vert mousse
moosgrün
mosgroen
verde musgo

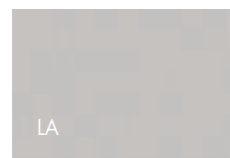

alluminio
aluminium
aluminium
Aluminium
aluminium
aluminio

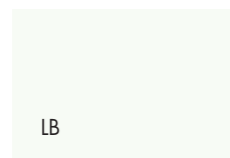

bianco
white
blanc
Weiß
wit
blanco

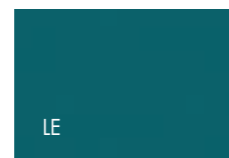

deep teal
deep teal
bleu canard
Deep Teal
deep teal
deep teal

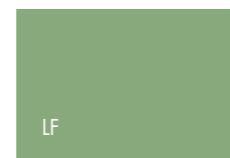

verde natura
gras green
vert nature
grasgrün
groene natuur
verde naturaleza

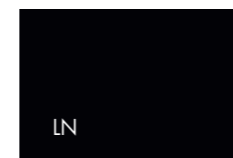

nero
black
noir
Schwarz
zwart
negro

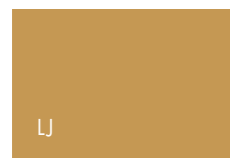

giallo gold
yellow gold
jaune or
goldgelb
geelgouden
loro amarillo



bordeaux
bordeaux
bordeaux
bordeaux
bordeaux
burdeos

finishes

melaminici

melamine · mélamine · Melamin · melamine · melamina

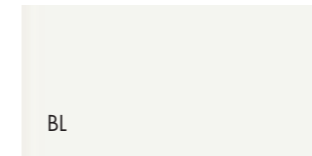

bianco
white
blanc
weiß
wit
blanco

parti metalliche

metal parts · pièces métalliques · metallteile · metalen onderdelen · piezas de metal



cromo lucido
glossy chrome
chromé brillant
Chrom poliert
glanzend verchroomd
cromo pulido



nero
black
noir
Schwarz
zwart
negro

vetro temperato

tempered glass · verre trempé · gehärtetes Glas · gehard glas · vidrio templado



trasparente
transparent
transparent
Transparentes
transparente
transparente

vetroceramica

glass ceramic · vitroceramique · glaskeramik · vitrokeramisch · vitroceramica



Bianco Calacatta lucido
Glossy white Calacatta
Blanc brillant Calacatta
Weiß glänzend Calacatta
Glanzend wit Calacatta
Calacatta blanco brillo



Grigio Stone opaco
Stone grey matt
Gris mat Stone
Grau matt Stone
Grijs Stone mat
Gris mate Stone



Nero Marquinia opaco
Marquinia black matt
Noir mat Marquinia
Schwarz matt Marquinia
Zwart Marquinia mat
Marquinia negro mate

pelle ecologica

eco leather · cuir écologique · ecopell-leder · Kunstleder · piel ecológica

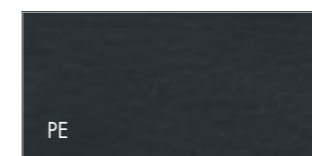

nero
black
noir
Schwarz
zwart
negro

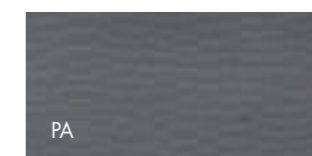

titanio
titanium coloured
titane
Titan
titanium
titanio

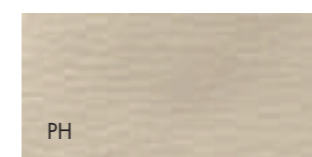

Nebbia
dark white colour
brouillard
Nebel
Grijswit
gris claro

rail

technical info

scrivania in legno · wooden desk · bureau en bois
Schreibtisch aus Holz · bureau in hout · escritorio de madera

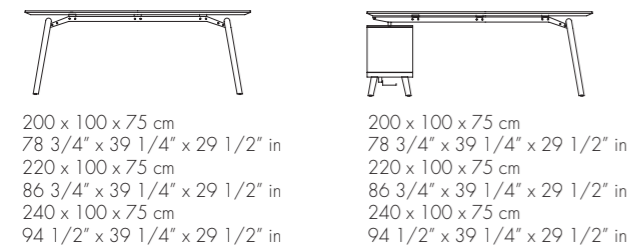

200 x 100 x 75 cm
78 3/4" x 39 1/4" x 29 1/2" in
220 x 100 x 75 cm
86 3/4" x 39 1/4" x 29 1/2" in
240 x 100 x 75 cm
94 1/2" x 39 1/4" x 29 1/2" in

scrivania in vetro · glass desk · bureau en verre
Schreibtisch aus Glas · bureau in glas · escritorio de cristal

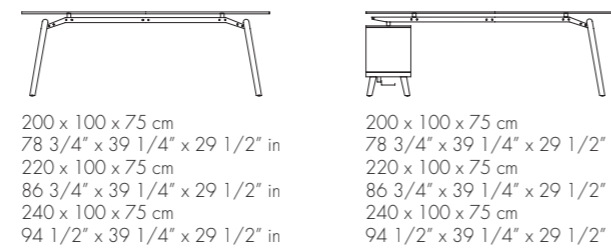

200 x 100 x 75 cm
78 3/4" x 39 1/4" x 29 1/2" in
220 x 100 x 75 cm
86 3/4" x 39 1/4" x 29 1/2" in
240 x 100 x 75 cm
94 1/2" x 39 1/4" x 29 1/2" in

scrivania in legno · wooden desk · bureau en bois
Schreibtisch aus Holz · bureau in hout · escritorio de madera

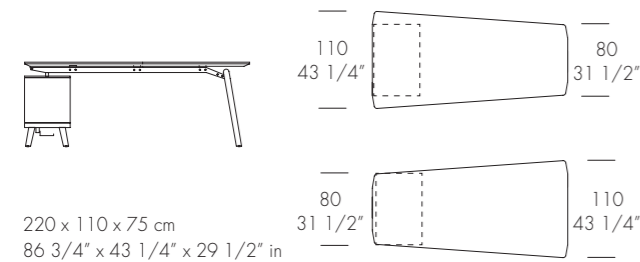

220 x 110 x 75 cm
86 3/4" x 43 1/4" x 29 1/2" in

scrivania in vetro · glass desk · bureau en verre
Schreibtisch aus Glas · bureau in glas · escritorio de cristal

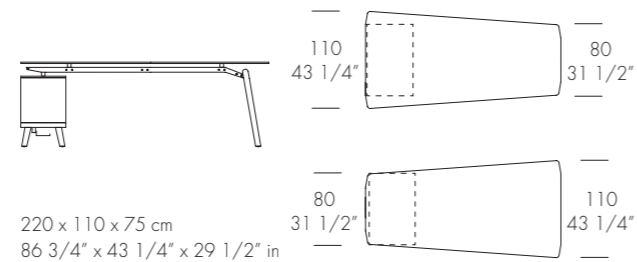

220 x 110 x 75 cm
86 3/4" x 43 1/4" x 29 1/2" in

pannello modesty · modesty panel · voile de fond · Modesty Paneel · knieschot · panel de protección



LG 200 152 x 1,9 x 28 LG 78 3/4" 59 3/4" x 3/4" x 11" in
LG 220 172 x 1,9 x 28 LG 86 3/4" 67 3/4" x 3/4" x 11" in
LG 240 192 x 1,9 x 28 LG 34 1/2" 75 1/2" x 3/4" x 11" in

posizione passacavi · cable guide position · position passe-câbles · Kabeldurchlass Position · positie kabeldoorvoer · posición pasacables

scrivania in legno · wooden desk · bureau en bois
Schreibtisch aus Holz · bureau in hout · escritorio de madera

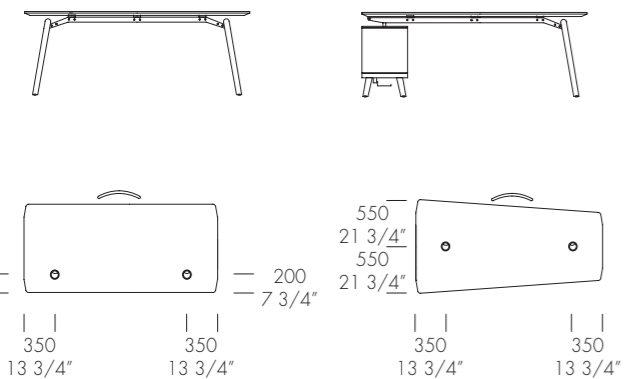

200 x 7 3/4" x 350 x 13 3/4" in

scrivania in vetro · glass desk · bureau en verre
Schreibtisch aus Glas · bureau in glas · escritorio de cristal

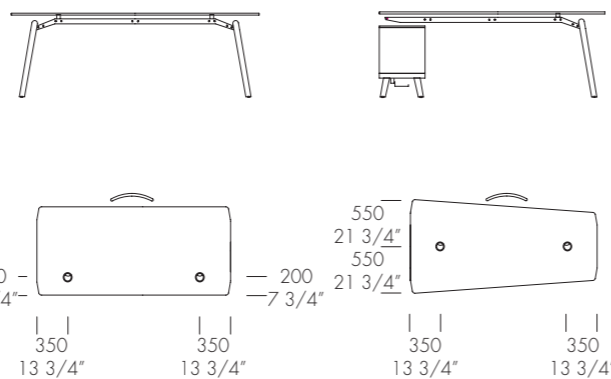

200 x 7 3/4" x 350 x 13 3/4" in

* con passacavi · with cable guide · avec passe-câbles · mit Kabeldurchlass · met kabeldoorvoer · con pasacables

tavolo riunione in legno · wooden conference table · table de réunion en bois
Konferenztisch aus Holz · vergadertafel in hout · mesa de reuniones de madera

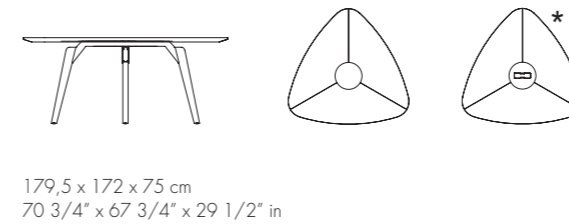

179,5 x 172 x 75 cm
70 3/4" x 67 3/4" x 29 1/2" in

tavolo riunione in vetro · glass conference table · table de réunion en verre
Konferenztisch aus Glas · vergadertafel in glazen · mesa de reuniones de cristal

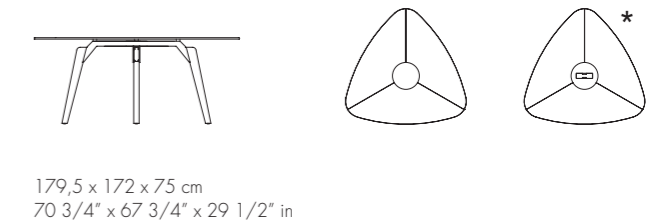

179,5 x 172 x 75 cm
70 3/4" x 67 3/4" x 29 1/2" in

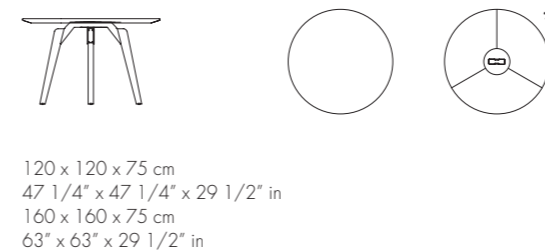

120 x 120 x 75 cm
47 1/4" x 47 1/4" x 29 1/2" in
160 x 160 x 75 cm
63" x 63" x 29 1/2" in

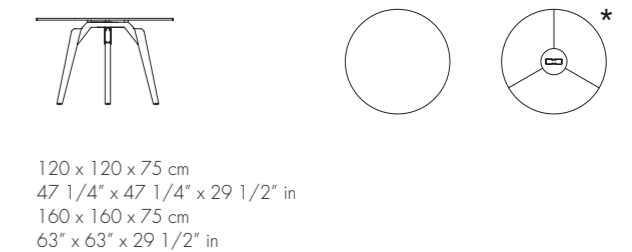

120 x 120 x 75 cm
47 1/4" x 47 1/4" x 29 1/2" in
160 x 160 x 75 cm
63" x 63" x 29 1/2" in

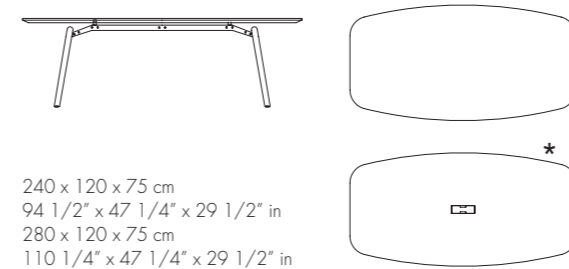

240 x 120 x 75 cm
94 1/2" x 47 1/4" x 29 1/2" in
280 x 120 x 75 cm
110 1/4" x 47 1/4" x 29 1/2" in

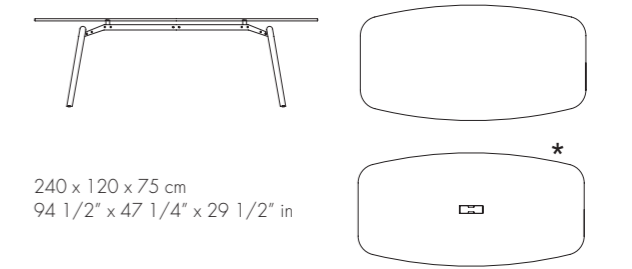

240 x 120 x 75 cm
94 1/2" x 47 1/4" x 29 1/2" in

tavolo riunione in legno · wooden conference table · table de réunion en bois · Konferenztisch aus Holz · vergadertafel in hout · mesa de reuniones de madera



360 x 120 x 75 cm
141 3/4" x 47 1/4" x 29 1/2" in

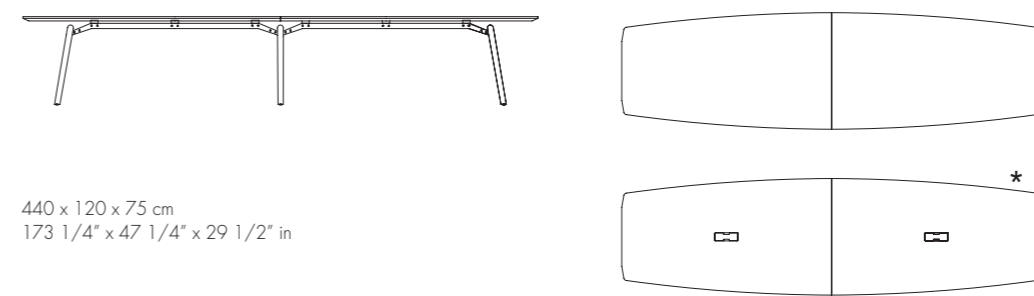

440 x 120 x 75 cm
173 1/4" x 47 1/4" x 29 1/2" in

rail

technical info

mobili di servizio · service cabinets · dessertes · Werkbox/Module · meubels · muebles de servicio

L x P x H

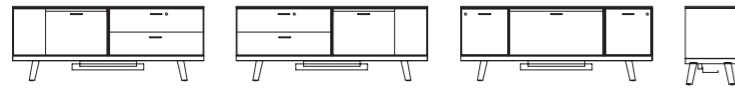

160 x 40 x 62 cm
63" x 15 3/4" x 24 1/2" in

160 x 40 x 62 cm
63" x 15 3/4" x 24 1/2" in

160 x 40 x 62 cm
63" x 15 3/4" x 24 1/2" in

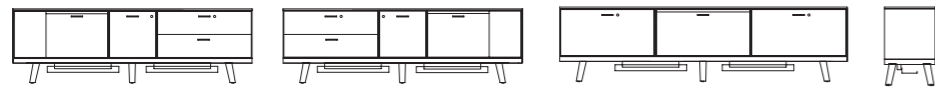

200 x 40 x 62 cm
78 3/4" x 15 3/4" x 24 1/2" in

200 x 40 x 62 cm
78 3/4" x 15 3/4" x 24 1/2" in

240 x 40 x 62 cm
94 1/2" x 15 3/4" x 24 1/2" in

credenze · cabinets · armoires basses · Schränke · kasten · aparadores

L x P x H

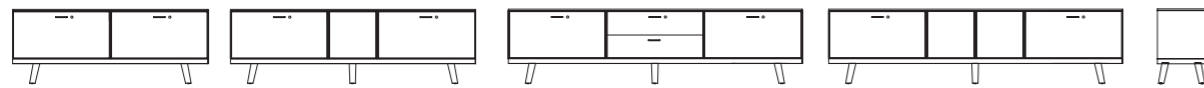

160 x 40 x 62 cm
63" x 15 3/4" x 24 1/2" in

200 x 40 x 62 cm
78 3/4" x 15 3/4" x 24 1/2" in

240 x 40 x 62 cm
94 1/2" x 15 3/4" x 24 1/2" in

240 x 40 x 62 cm
94 1/2" x 15 3/4" x 24 1/2" in

mobili di servizio · service cabinets · dessertes · Werkbox/Module · meubels · muebles de servicio

L x P x H

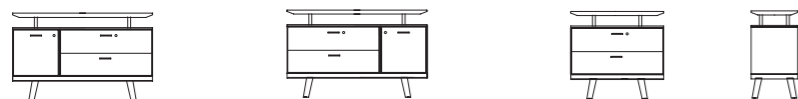

legno · wood
bois · Holz
hout · madera

120 x 40 x 75 cm
47 1/4" x 15 3/4" x 29 1/2" in

legno · wood
bois · Holz
hout · madera

120 x 40 x 75 cm
47 1/4" x 15 3/4" x 29 1/2" in

legno · wood
bois · Holz
hout · madera

80 x 40 x 75 cm
31 1/2" x 15 3/4" x 29 1/2" in

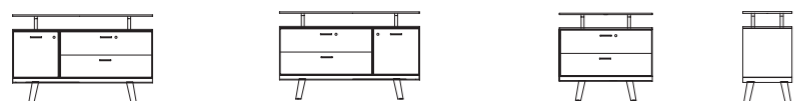

vetro · glass
verre · Glas
glas · cristal

120 x 40 x 75 cm
47 1/4" x 15 3/4" x 29 1/2" in

vetro · glass
verre · Glas
glas · cristal

120 x 40 x 75 cm
47 1/4" x 15 3/4" x 29 1/2" in

vetro · glass
verre · Glas
glas · cristal

80 x 40 x 75 cm
31 1/2" x 15 3/4" x 29 1/2" in

credenze · cabinets · armoires basses · Schränke · kasten · aparadores

L x P x H

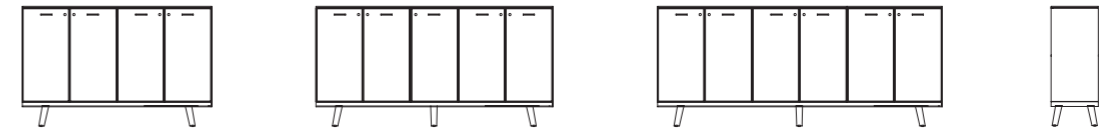

160 x 40 x 102 cm
63" x 15 3/4" x 40" in

200 x 40 x 102 cm
78 3/4" x 15 3/4" x 40" in

240 x 40 x 102 cm
94 1/2" x 15 3/4" x 40" in

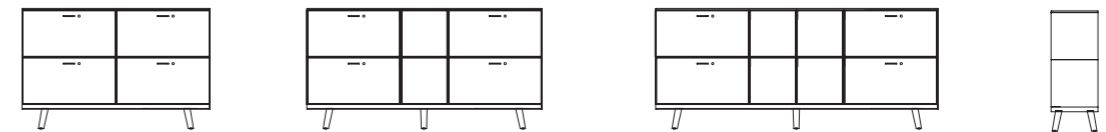

160 x 40 x 102 cm
63" x 15 3/4" x 40" in

200 x 40 x 102 cm
78 3/4" x 15 3/4" x 40" in

240 x 40 x 102 cm
94 1/2" x 15 3/4" x 40" in

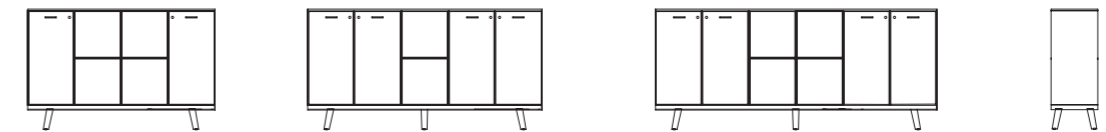

160 x 40 x 102 cm
63" x 15 3/4" x 40" in

200 x 40 x 102 cm
78 3/4" x 15 3/4" x 40" in

240 x 40 x 102 cm
94 1/2" x 15 3/4" x 40" in

project & graphic design

consilia.it

rendered images

gabriotti fotografi

separation

lucegroup.it

print

grafiche antiga

paper

sappi | Magno™ natural 300gr

sappi | Magno™ matt 170gr

fonts

Futura Std Light, Futura Std Book

Charis SIL Bold, Charis SIL Italic

Per le sedute e per le poltrone si ringrazia TCC

made and printed in Italy

July 2015

reprinted

September 2018

Particolari tecnici, estetici, finiture o altro possono essere modificati senza preavviso.

Product details, aesthetics, finishes or other data may be subject to change without notice.

Les détails de produit, l'esthétique, les finitions ou d'autres données peuvent être sujets à changement sans communication préalable.

Produktdetails, Ästhetik, Ende oder andere Daten können abhängig von Änderung ohne Nachricht sein.

De details van het product, esthetica, eindigt of andere gegevens kunnen zonder bericht voor wijzigingen vatbaar zijn.

Los detalles del producto, la estética, los finales u otros datos pueden estar conforme a cambio sin el aviso.

Bralco s.r.l.

Via Luigi Einaudi, 1

31058 Susegana · TV

T +39 0438 43 77 11

F +39 0438 43 77 30

info@bralco.it

www.bralco.it

7MIDERAILO3

milan
paris
london
bruxelles
valencia
athens
prague

ww.bralco.it