

papilio



KUSCH+CO



Experience the best possible comfort. This ergonomic task chair series encourages you to dynamically vary your postures. The clean lines are the hallmarks of this series' industrial design language. The constructive elements double as design features. Available in many variations geared towards a plethora of working environments, functionally complemented by visitor chairs.



Content

| | |
|---------------------|----|
| Variations | 6 |
| Product data | 10 |
| Ergonomics | 16 |
| Materials, finishes | 19 |
| Solutions | 20 |
| Quality | 21 |
| Sustainability | 22 |
| References | 23 |



Design by Justus Kolberg

After having studied industrial design in Kiel, he started for Italian design studios. Upon his return to Germany, he designed several successful seating series for Wiege Entwicklungsgesellschaft. He is a freelancer since 1997. Many internationally renowned furniture manufacturers value his intelligent designs. As does Kusch+Co by giving him the opportunity to develop his special passion for contract seating.





Variations

9200 Swivel side chair / swivel armchair

Whether in the office or in a conference room, Papilio always provides the best possible comfort. The task chairs come with an upholstered backrest available in two heights or with a high mesh backrest. The swivel armchair either features 2D or 3D armrests; glides instead of castors are optional.



9200 Swivel counter side chair / swivel counter armchair

The high variation of the swivel chairs / swivel armchairs featuring a chrome footrest are ideally suited for workstations where customers must be addressed at eye level. Available with a medium-high upholstered backrest or a high mesh backrest. The counter swivel armchair comes with 2D or optional 3D arms.



9230 Cantilever

The cantilevers, characterised by clean lines and optimum ergonomics, are ideally cut out for use in waiting areas and conference rooms.

The armchairs feature a generously sized upholstered backrest as well as elegantly arched armrests. A stacking cantilever frame is optionally available.



9270 Cantilever

These cantilevers offer a great deal of scope to tailor the backrest design to the interior.

The cantilever side chairs and armchairs can be combined with a mesh backrest, a perforated plastic backrest or a plastic backrest with an upholstered pad. A stacking cantilever frame is optionally available.



Variations

9200 Swivel side chair / swivel armchair



Medium-high upholstered back

9256/1

9256/3

High upholstered back

**9257/1,
9257/1H**

**9257/3,
9257/3H**

High mesh back

9227/1

9227/3

9200 Swivel counter side chair / swivel counter armchair



Medium-high upholstered back

9260/1

9260/3

High mesh back

9265/1

9265/3

All variations, whose model numbers end with the letter H, meet the standards of the kuschmed® Hygienic-Line. For more information, please go to the Solutions section

9230 Cantilever

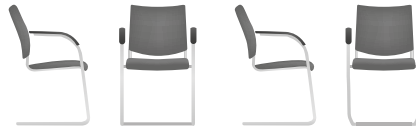

Upholstered back

9230/3

9230/4

9270 Cantilever



Mesh back

9272/1

9272/2

9272/3

9272/4

Plastic back

9277/1

9277/2

9277/3

9277/4

Plastic back, upholstered back pad

9279/1

9279/2

9279/3

9279/4

Product data

9200 Swivel side chair / swivel armchair

Accessories

- Adjustable seat inclination/forward tilt
- Comfort gas action SH DIN 44 – 58 cm
- Lumbar support, pneumatic (for high upholstered back)
- Lumbar support, continuously depth adjustable by 2 cm, height adjustable by 10 cm, size 34 × 11.5 cm, height above seat in middle position amounts to 19 cm (for mesh back)
- Black plastic neck support with upholstered pad, fabric material as well as upholstery, or with black PU pad (not available for medium-high upholstered back)
- Black plastic coat hanger
- Individual logo points
- Hard or soft black castors
- Hard or soft premium castors with chrome-plated ring
- Plastic glides (height – 3 cm)

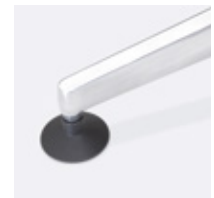
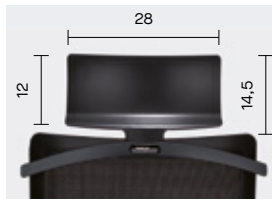

¹ The DIN seat height was determined acc. to DIN EN 1335-1, i.e. the seat height measured by means of a measuring device at the position of the ischial tuberosity (sitting bones) after having placed a load of 50 kg on the half width of the seat.

² Medium-high upholstered back

³ High upholstered back

Dimensions in cm

9200 Swivel side chair / swivel armchair

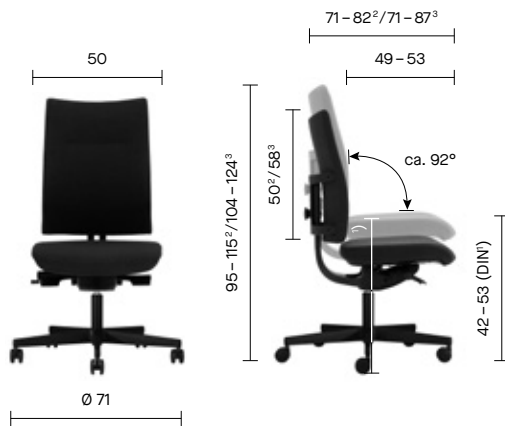

Weight: 18.5 – 19.0 kg depending on model

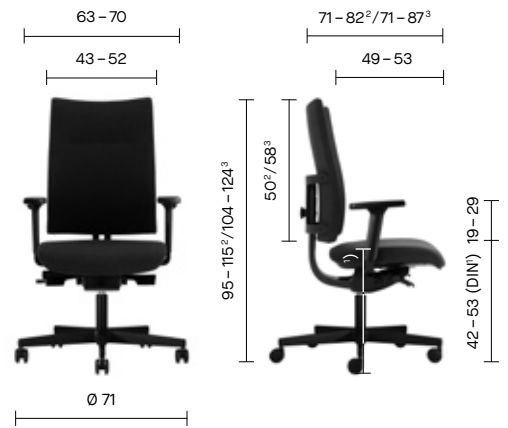

Weight: 18.5 – 19.0 kg depending on model

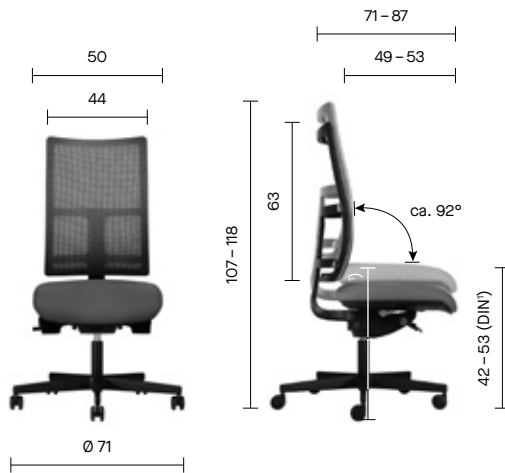

Weight: 16.5 kg

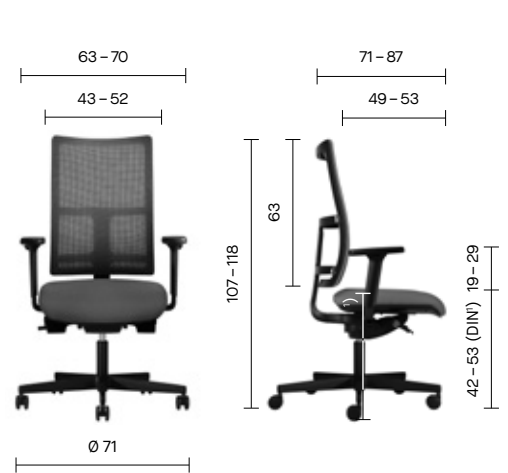

Weight: 16.5 kg

Product data

9200 Swivel counter side chair / swivel counter armchair

Accessories

- Adjustable seat inclination/forward tilt
- Lumbar support, continuously depth adjustable by 2 cm, height adjustable by 10 cm, size 34 × 11.5 cm, height above seat in middle position amounts to 19 cm (for mesh back)
- Black plastic neck support with upholstered pad, fabric material as well as upholstery, or with black PU pad (for mesh back)
- Black plastic coat hanger
- Individual logo points
- Footring bright chrome, height adjustable, Ø 60 cm
- Plastic glides
- Felt glides
- Glides with stainless steel cap

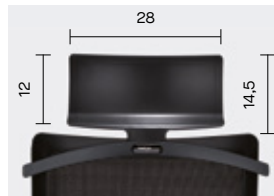

¹ The DIN seat height was determined acc. to DIN EN 1335-1, i.e. the seat height measured by means of a measuring device at the position of the ischial tuberosity (sitting bones) after having placed a load of 50 kg on the half width of the seat.

9200 Swivel counter side chair / swivel counter armchair

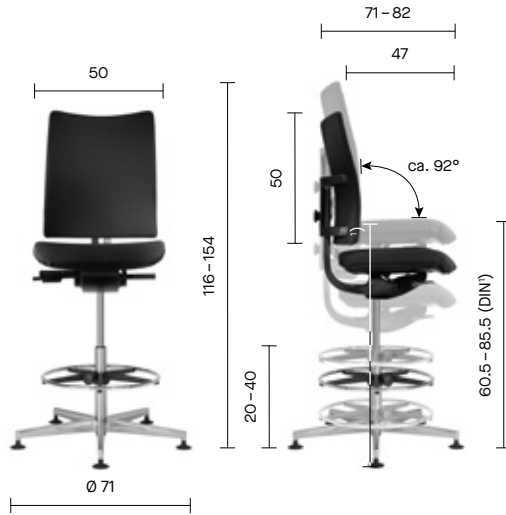

Weight: 18.0 kg

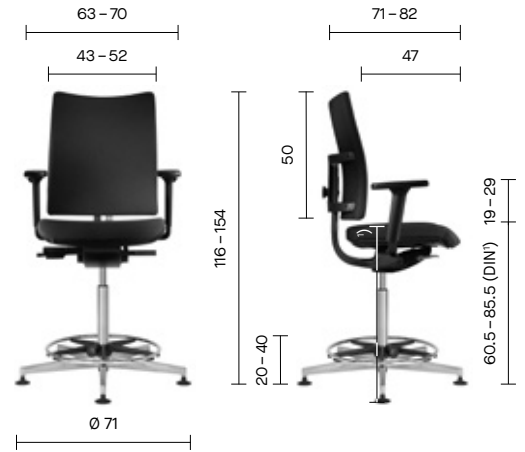

Weight: 19.5 kg

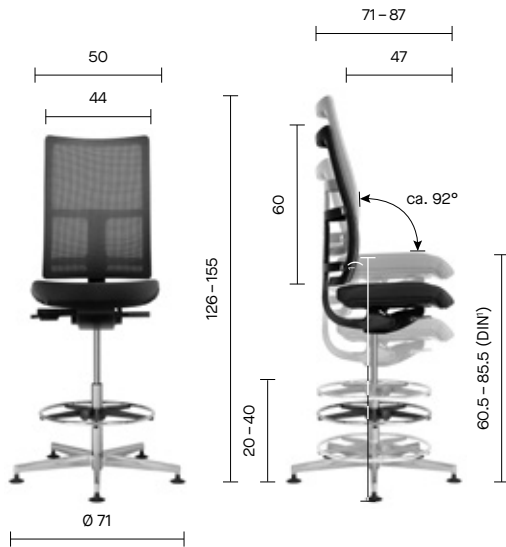

Weight: 16.0 kg

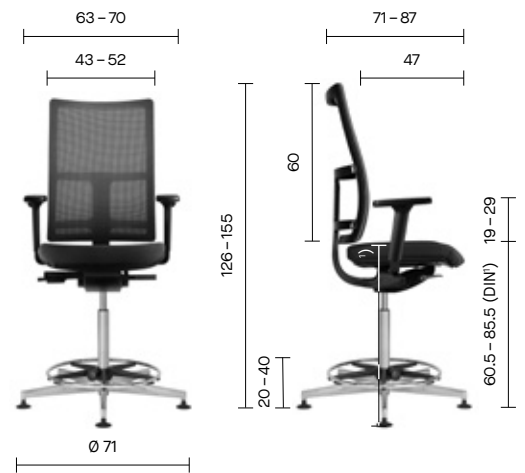

Weight: 17.5 kg

Product data

9230 Cantilever

Accessories

- Plastic glides
- Felt glides

Stackability

- Stackable on dolly 3880/8: 5 units
- Stackable on dolly 3980/8: 5 units
- Stackable on dolly 3981/8: 5 units
- Stacks of max. 5 units on a straight surface
- Height plus 7 cm per stacking armchair
- Depth plus 5 cm per stacking armchair

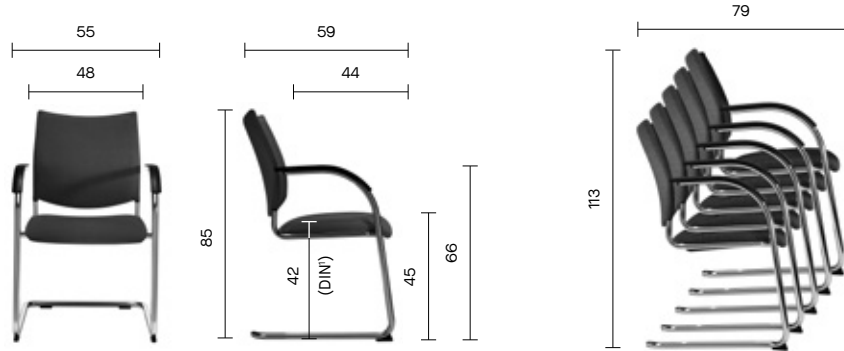

Weight: 10.5 kg

9270 Cantilever

Accessories

- Plastic glides
- Felt glides
- Protect glides



9272

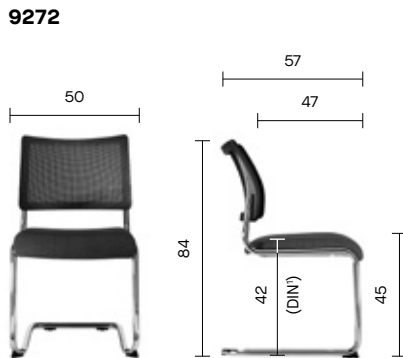

Weight: 8.5 kg

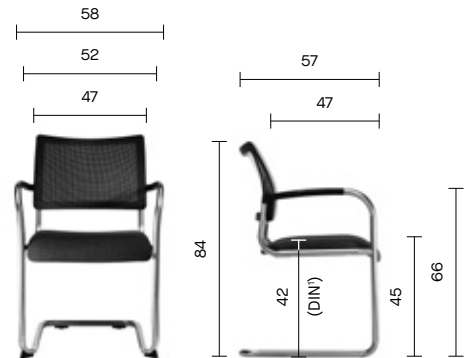

Weight: 10.0 kg

9277 / 9279

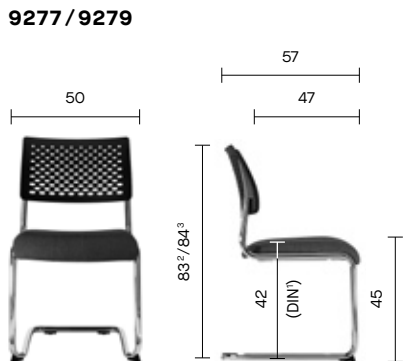

Weight: 8.5 – 9.0 kg depending on model

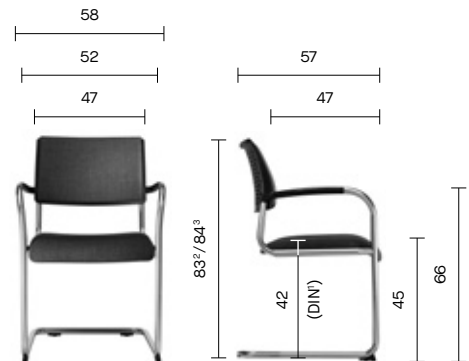

Weight: 10.0 – 10.5 kg depending on model

¹ The DIN seat height was determined acc. to DIN EN 1335-1, i.e. the seat height measured by means of a measuring device at the position of the ischial tuberosity (sitting bones) after having placed a load of 50 kg on the half width of the seat.

² Back without upholstered pad

³ Back with upholstered pad

Dimensions in cm

9270 Cantilever

Stackability

- Stackable on dolly 3880/8: 6 units
- Stackable on dolly 3980/8: 6 units
- Stackable on dolly 3981/8: 6 units
- Stacks of max. 6 units on a straight surface
- Height plus 8 cm per stacking side chair/ armchair
- Depth plus 6 cm per stacking side chair/ armchair
- Mixed stacks of side chairs and armchairs possible

9272

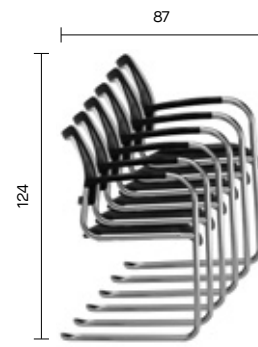
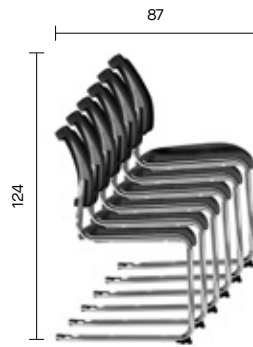

9277 / 9279

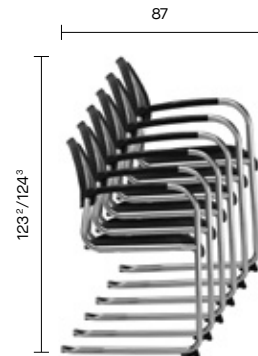
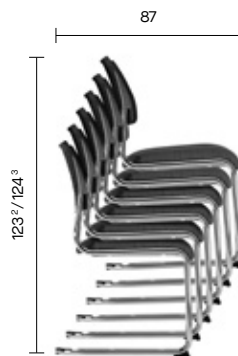

Ergonomics

Healthy comfort

As standard, the task chairs and task armchairs feature a dual synchronized mechanism as well as a seat height, seat depth and forward tilt adjustment, promoting a dynamic posture and keeping the user from adopting a permanent incorrect posture. The variations with an upholstered back feature an adaptable seat depth.

The ergonomic motion sequence of the dual synchronized mechanism closely approximates the ideal of the kinematic equilibrium.

The entire seat curves backwards and downwards in an arch. The seat and the backrest move relative to each other at a tilt ratio of 1:2.7. Seat and back support the user in his every move or change of posture, ranging from upright sitting in front of the PC monitor to leaning back in a more relaxed posture. The supporting spring force exerted by the backrest increases proportionally.

The ergonomically shaped backrest provides more "elbow room" to the shoulder blades

and leaves more room for the arm muscles to stay in motion. As a result, it is easier for the user to turn sideways, for instance to take a ring binder out of the filing cabinet. The upper body remains supported by the flexible frame construction and the mesh back.

Options such as height, depth and width adjustable and swivelling armrests offer additional ergonomic advantages. The same goes for the neck support as well as the adjustable resp. pneumatic lumbar support for the high back, depending on the variation.

9200 Swivel side chair / swivel armchair

Seat

- Anatomically shaped seat
- Ergonomically shaped leg support
- Gas action capable of carrying a body weight up to 130 kg
- Comfort gas action with permanent depth cushioning
- Comfort gas action SH DIN 44 – 58 cm
- Adjustable forward tilt by -3°
- Seat depth adjustment by 4 cm in 5 positions

Back

- Dual synchronized mechanism
- Medium-high or high upholstered back with ergonomic moulded part made of polypropylene, height adjustable in 7 positions
- High mesh back frame made of glass fibre reinforced polyamide

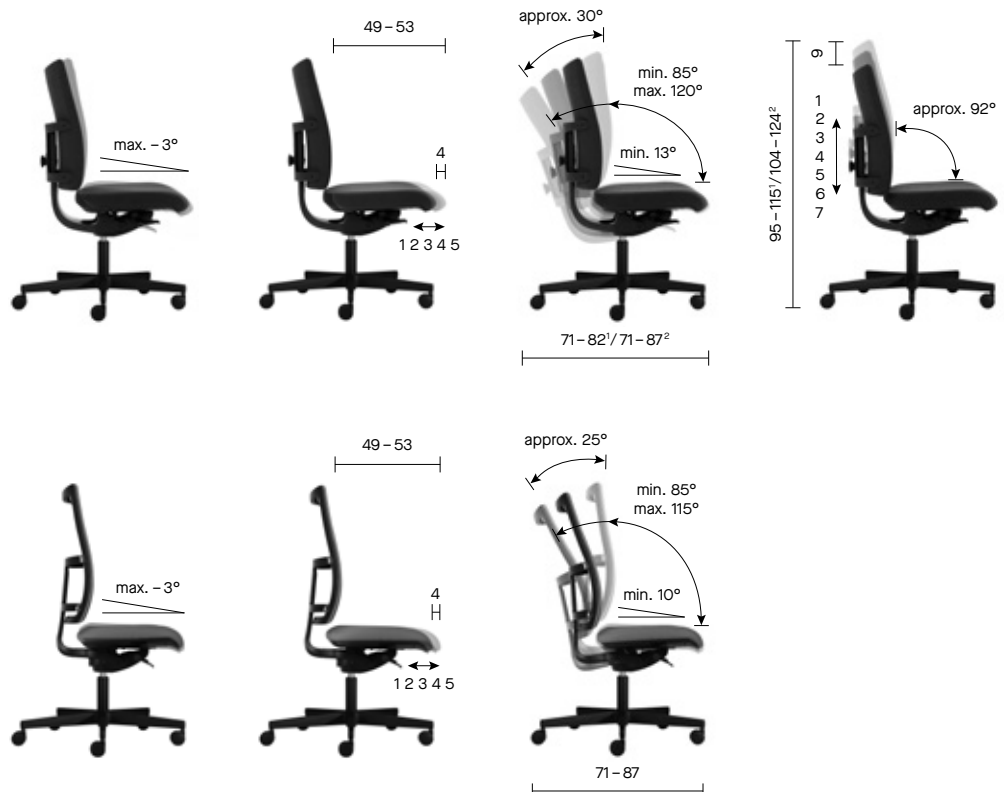

¹ Medium-high upholstered back
² High upholstered back

Dimensions in cm

9200 Swivel counter side chair / swivel counter armchair

Seat

- Anatomically shaped seat
- Ergonomically shaped leg support
- Gas action capable of carrying a body weight up to 130 kg
- Comfort gas action with permanent depth cushioning
- Adjustable forward tilt by -3°

Back

- Dual synchronized mechanism
- Medium-high or high upholstered back with ergonomic moulded part made of polypropylene, height adjustable in 7 positions
- High mesh back frame made of glass fibre reinforced polyamide

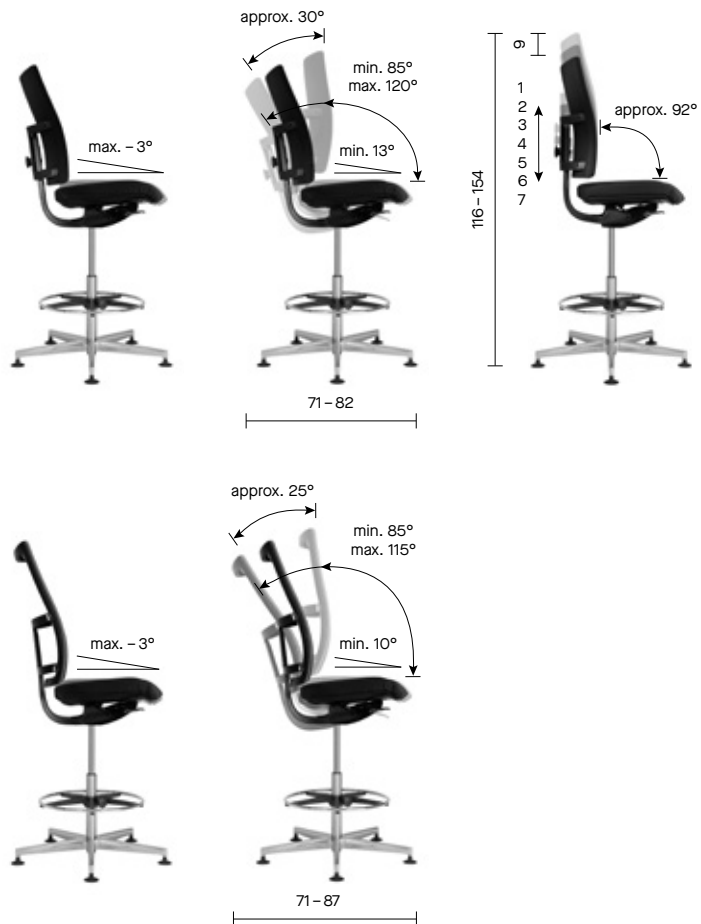

9200 Swivel side chair / swivel armchair, 9200 Swivel counter side chair / swivel counter armchair

Armrests



2D arms with black PU pads, black plastic supports



3D arms with black PU pads, black plastic supports



3D arms with black PU pads, polished aluminium supports

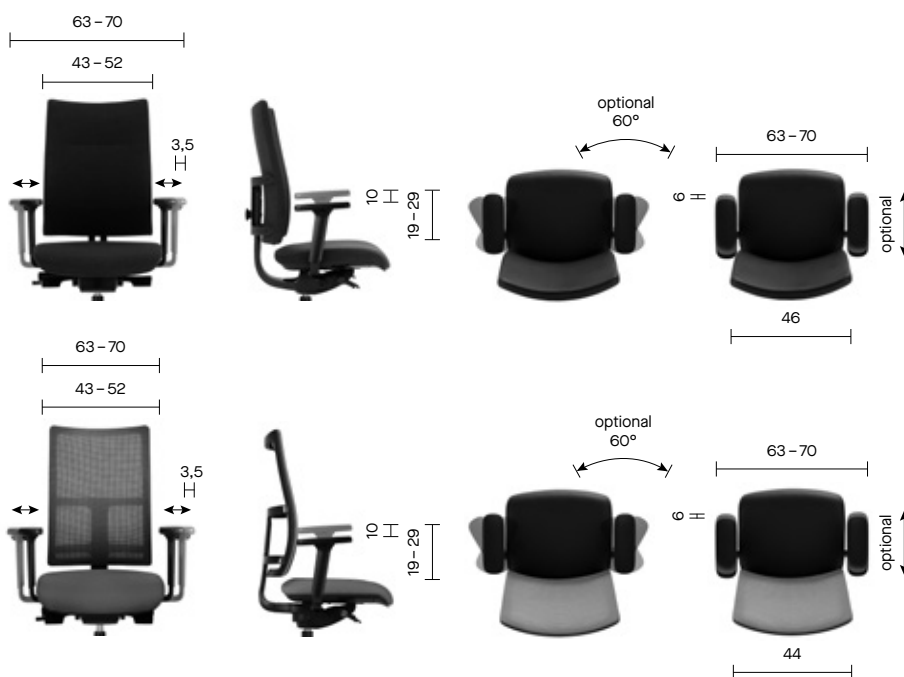

Handling

Nearly all the operating elements, including those of the dual synchronised mechanism, are easily accessible without the need of having to get up. The backrest counterpressure can be individually adjusted to the body weight and to the user's personal liking by means of a

smooth-running turning handle. With a range of 40 rotations, the counterpressure can be adjusted to a body weight between 40 and 120 kg. The turning handle as well as the locking lever are within easy reach.

Materials, finishes

Modular assembly groups

The modular construction principle makes it possible to build many different variations, or to exchange individual parts or assembly groups.

Cost-effective and resource-friendly at the same time. All components can be dismantled for recycling at the end of the product's life cycle.

9200 Swivel side chair / swivel armchair, 9200 Swivel counter side chair / swivel counter armchair

Seat, back

- Black plastic seat base and backrest frame
- Black plastic backrest frame (mesh back)
- Upholstered seat/back, fabric from standard collection
- Black mesh back or fabric 3D Net Textile (also available as seat cover), upholstered seat, fabric from standard collection

- Optional seat with flame retardant foam resp. with flame retardant foam and fireproof fabric (for models with mesh back)

Frame

- Base, black plastic, powder-coated aluminium or polished aluminium

Arms

- 2D arms with black PU pads, black plastic supports
- 3D arms with black PU pads, black plastic or polished aluminium supports

9230 Cantilever, 9270 Cantilever

Seat

- Seat upholstered acc. to standard collection
- Optionally available with upholstery with flame retardant foam resp. flame retardant foam and fireproof fabric

Upholstered back

- Back with upholstered pad, fabric acc. to standard collection
- Optionally available with upholstery with flame retardant foam resp. flame-retardant foam and fireproof fabric

Mesh back

- Black plastic backrest frame
- Black mesh back or fabric 3D Net Textile (also available as seat cover)

Plastic back

- Black plastic back with perforated pattern
- Back with upholstered pad, fabric acc. to standard collection
- Optionally available with upholstery with flame retardant foam resp. flame retardant foam and fireproof fabric

Frame, arms

- Powder coated, protective lacquer aluminium powder coated (only for stacking models), bright chrome or satin chrome steel frame
- Black plastic arms

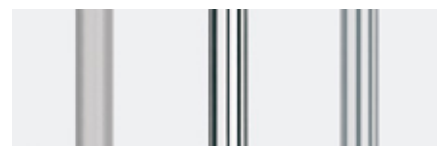

Depending on the environment, contract seating has to be able to fulfil very specific requirements. Interior designers and planners sometimes have to clear difficult hurdles: such as exacting fire prevention or hygiene regulations. Kusch+Co has worked out individual solutions:

Fire Prevention

Upholstery

The upholstery is optionally available with flame retardant foam. In addition, it is available with the Kusch+Co Fire Prevention Concept, consisting of a special fabric “flamline” (approved by the building authorities and conforms to DIN 4102 A2 non-flammable) between the upholstery foam and the fabric. The optional upholstery is only available for the 9200 variations with mesh back, 9230 and 9270.

This concept achieves four life-saving objectives. The seating:

- is self-extinguishing,
- reduces the smoke development,
- prevents an incipient fire from spreading out,
- does not turn into an additional ignition source.

Test reports in compliance with national and international standards document the laboratory fire tests conducted on different series finished with a wide variety of materials.

With regard to the upholstery, e.g. with leather, artificial leather as well as many textile fabrics, or to our unupholstered variations featuring a plywood, laminated or plastic seat shell, most of our series meet the following standards:

- Germany: DIN 66084 P-a
- France: NF D 60-013
- Great Britain: BS 5852 Crib 5
- Italy: UNI 9176
- Europe: EN 1021 part 1/2

Please contact us if you wish to receive the test reports.

Hygiene

kuschmed® Hygienic-Line

Products from the kuschmed® Hygienic-Line provide an unfavourable breeding ground for bacteria, germs, and mildew. For this purpose, this range is conceived without open-pored veneers, slits in the backrest, improper upholstery, finger traps, open frames, felt glides, or materials that degrade upon contact with disinfectants.

Only fabrics with specific properties, e.g. hygienically impervious fabrics as well as water- and dirt-repellent finishes, qualify for this product line. Fabrics made of nano-coated fibres as well as disinfectant-compatible fabrics are also used.

The surfaces have to be smooth and pore-free, impervious to liquids and germs, and growth-inhibiting for bacteria. All wooden surfaces are entirely sealed with a special high-density, pore-free and disinfectant-resistant lacquer with antibacterial properties. Metal surfaces are sealed with a chrome finish or with a silver-bearing, anti-bacterial powder coating. The silver ions within the coating are activated upon contact with bacterial colonies, diffusing at the surface, denaturing the cell walls of the bacteria, and thus inhibiting their growth.

kuschmed®
HYGIENIC-LINE

Please contact us to receive further information.

Quality

Excerpt

Our environmental and quality management systems are certified acc. to DIN EN ISO 14001:2015 and to DIN EN ISO 9001:2015. External audits as well as our in-house laboratory safeguard our quality level.

All variations of series 9200 Papilio meet the requirements with regard to stability, static and dynamic load as well as strength and durability in compliance with the current European Directives, standards and regulations.

On top of this, we test most of our contract seating with higher loads and cycles. On request, we conduct individual tests acc. to the customer's specifications. All variations are designed to support a body weight of 130 kg in full-time use.

We are certified in compliance with DIN EN ISO 9001:2015. In our own laboratory, we test our products before their market launch whether they comply with the normative requirements applicable to contract seating, task chairs, and tables, and issue a Declaration of Conformity.

We happily make these Declarations of Conformity as well as our brochure "Mission Statement Quality" providing detailed information on our test procedures available to you – please contact us.



9227/1, 9227/3, 9256/1, 9256/3, 9257/1, 9257/3

9227/1, 9227/3, 9256/1, 9256/3, 9257/1, 9257/3



9230/3, 9230/4



How we test our seating

Test in compliance with DIN EN 1335-3:2009

Our tests exceeds the recommended number of test cycles stipulated in DIN EN 1335-3:2009.

Test procedure

We always test the chairs and armchairs in their least favourable position in order to detect possible flaws. The chair's/armchair's upper part is turned and fixed in such a position that the seat is perpendicular to the one of the prongs.

The force has to be directed vertically onto the seat. The backrest forces have to be applied in an angle of $90^\circ \pm 10^\circ$ to the backrest, under full load. The backrest's inclination has to be fixed in order to test the fixed backrest under full force application. Both seat and backrest have to be tested as specified in the chart.

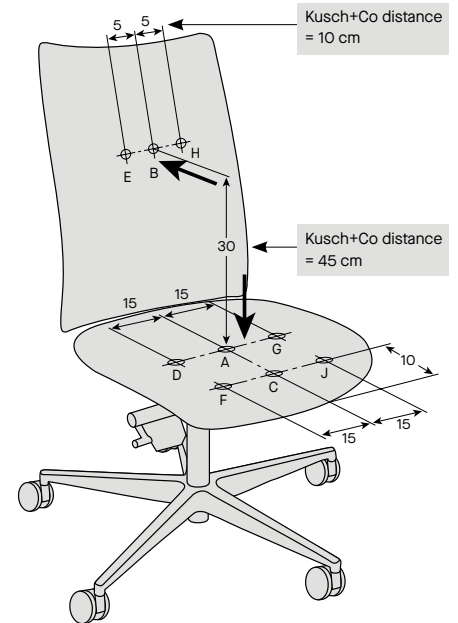

Force application points on seat and backrest (dimensions in cm)

Sequence of tests, force application and cycles on the seat and backrest

| Step | Sequence | Force application point | Force in kg | | Number of cycles | |
|------|----------|-------------------------|-------------|------------|--------------------------|---------------------------|
| | | | DIN | Kusch + Co | DIN | Kusch + Co |
| 1 | A | A | 150 | 150 | 120,000 | 120,000 |
| 2 | C – B | C B | 120 32 | 120 35 | in alternation 80,000 | in alternation 240,000 |
| 3 | J – E | J E | 120 32 | 120 35 | in alternation 20,000 | in alternation 60,000 |
| 4 | F – H | F H | 120 32 | 120 35 | in alternation 20,000 | in alternation 60,000 |
| 5 | D – G | D G | 110 110 | 110 110 | in alternation 20,000 | in alternation 20,000 |

Each test has to be successful before the next test is carried out on the same chair/armchair. The same chair/armchair is used for all other tests, such as stability etc. These tests are an integral part of our test procedure.

Kusch+Co products stand for long life cycles and optimum recyclability. From the first design drafts of a new product, we take all environmental-relevant components and production processes into consideration, ranging from the materials selection and the

design all the way to the manufacturing processes which also contribute towards our sustainable energy balance.

Environmental Product Declarations are available for all series, in accordance with DIN EN ISO 14021 Type II, providing more information about all environmentally relevant aspects, including the Credit Points for the LEED certification of a building. Please contact us for more information.

KUSCH+CO

9200 Papilio
Environmental aspects



Environmental Product Declaration
In accordance with ISO 14021, type II

Environmental responsibility

Long before the production of a new series, Kusch+Co starts thinking about the possible environmental impact of the production processes and the required components.

Sustainability

Kusch+Co understands sustainability as the realistic, manageable and economically viable combination of environmental protection, economics and CSR, not only in terms of production, but also how we communicate with our fellow men, our staff members and partners. Sustainability cannot be measured, but it can be sensed.

Quality assurance

In order to guarantee a constant high-level product quality, Kusch+Co is certified in accordance with the quality management system DIN EN ISO 9001:2015 and the environmental management system DIN EN ISO 14001:2015. We offer a 5-year warranty as standard.

Life Cycle

1 Materials

- The models of series 9200 Papilio are free from hazardous materials (lead, mercury, PVC).
- All components of series 9200 Papilio comply with the legal REA standards.
- Kusch+Co uses CFC- and formaldehyde-free foam only that meets the Delko-Tex® Standard 100.
- To the greatest possible extent, we use aqueous dispersion adhesives free from organic solvents to glue the foam pads to the seat shells/seat. Smallest amounts of solvent-based adhesives are indispensable for technical reasons; however, direct contact with the skin is impossible.
- All plastic parts are labelled properly for recycling.
- Series 9200 Papilio contains no substances included on the candidate list for authorisation according to § 17 of Regulation (EC) No 1907/2006 ("REACH").

2 Production

• Metal coating

The powder coating is free from volatile organic compounds (VOC) and heavy metals and therefore physiologically harmless. Our chrome-plating finish excels in corrosion protection and is physiologically harmless during the production and the service life of series 9200 Papilio. We do not use perfluorinated surfactants (PFPS) for our chrome-plating, as these surfactants are suspected of being carcinogenic.

• Waste management

All types of process waste (fabric remnants, foam, metal tubes) are collected by professional waste processing companies and 100% recycled. All wood residues, resulting from wood-working, are used to heat the factory, saving precious heating oil.

3 Transportation

- The transportation energy is offset by the space-saving packaging.
- The packaging material is reused before it is recycled.
- Kusch+Co's dual disposal system is certified by Interserch. Approximately 20 tonnes of packaging material is recycled every year.

4 Usage

- In order to simulate the conditions of a 12-year service life, the series 9200 Papilio was tested for the GS mark for Product Safety with increased test cycles compared to the relevant norms.
- A long service life is guaranteed with most parts being exchangeable and reparable. That is our contribution to an efficient resource management.

5 Waste disposal

- At the end of their service life, the models of series 9200 Papilio can be disassembled by our professional workers who will separate the materials correctly by type.
- The models of series 9200 Papilio are recyclable to approx. 97%. The recyclability is exclusive of adhesives, grease, oil, small parts and screws.



KUSCH+CO

9200 Papilio
Environmental aspects



Environmental Product Declaration
In accordance with ISO 14021, type II

Environmental responsibility

Long before the production of a new series, Kusch+Co starts thinking about the possible environmental impact of the production processes and the required components.

Sustainability

Kusch+Co understands sustainability as the realistic, manageable and economically viable combination of environmental protection, economics and CSR, not only in terms of production, but also how we communicate with our fellow men, our staff members and partners. Sustainability cannot be measured, but it can be sensed.

Quality assurance

In order to guarantee a constant high-level product quality, Kusch+Co is certified in accordance with the quality management system DIN EN ISO 9001:2015 and the environmental management system DIN EN ISO 14001:2015. We offer a 5-year warranty as standard.

Life Cycle

1 Materials

- The models of series 9200 Papilio are free from hazardous materials (lead, mercury, PVC).
- All components of series 9200 Papilio comply with the legal REA standards.
- Kusch+Co uses CFC- and formaldehyde-free foam only that meets the Delko-Tex® Standard 100.
- To the greatest possible extent, we use aqueous dispersion adhesives free from organic solvents to glue the foam pads to the seat shells/seat. Smallest amounts of solvent-based adhesives are indispensable for technical reasons; however, direct contact with the skin is impossible.
- All plastic parts are labelled properly for recycling.
- Series 9200 Papilio contains no substances included on the candidate list for authorisation according to § 17 of Regulation (EC) No 1907/2006 ("REACH").

2 Production

• Metal coating

The powder coating is free from volatile organic compounds (VOC) and heavy metals and therefore physiologically harmless. Our chrome-plating finish excels in corrosion protection and is physiologically harmless during the production and the service life of series 9200 Papilio. We do not use perfluorinated surfactants (PFPS) for our chrome-plating, as these surfactants are suspected of being carcinogenic.

• Waste management

All types of process waste (fabric remnants, foam, metal tubes) are collected by professional waste processing companies and 100% recycled. All wood residues, resulting from wood-working, are used to heat the factory, saving precious heating oil.

3 Transportation

- The transportation energy is offset by the space-saving packaging.
- The packaging material is reused before it is recycled.
- Kusch+Co's dual disposal system is certified by Interserch. Approximately 20 tonnes of packaging material is recycled every year.

4 Usage

- In order to simulate the conditions of a 12-year service life, the series 9200 Papilio was tested for the GS mark for Product Safety with increased test cycles compared to the relevant norms.
- A long service life is guaranteed with most parts being exchangeable and reparable. That is our contribution to an efficient resource management.

5 Waste disposal

- At the end of their service life, the models of series 9200 Papilio can be disassembled by our professional workers who will separate the materials correctly by type.
- The models of series 9200 Papilio are recyclable to approx. 96%. The recyclability is exclusive of adhesives, grease, oil, small parts and screws.



References

Excerpt

Austria

- City Hall St. Pölten
- HDI Versicherung AG, Vienna
- Ricoh Austria GmbH, Vienna
- University of Applied Sciences Vienna
- Vienna International Airport – JET Lounge

Belgium

- Public Centre for Social Welfare Arendonk
- Residential care and nursing home Sint-Elisabeth, Ostend

Denmark

- Caggemini Sogeti Danmark A/S, Vallensbæk Strand

Egypt

- Cairo International Airport

France

- Viessmann France SAS, Faulquemont

Germany

- Agaplesion Diaconical Hospital Hamburg
- American Express Services Europe Limited, Frankfurt am Main
- Bayer Real Estate GmbH, Leverkusen
- Cruise Center Steinwerder, Hamburg
- Federal Joint Committee, Berlin
- Fraunhofer-Forum, Berlin
- German Aviation Association (BDL), Berlin
- Institute of Public Health Care at Maria Hospital, Wesel
- Medfacilities GmbH, Cologne
- TÜV Rheinland, Berlin
- University Hospital Cologne
- Viessmann Werke GmbH & Co. KG, Allendorf
- Zalando SE, Berlin

Italy

- Assicurazione Arag Spa, Verona

United Kingdom

- University of Strathclyde, Glasgow

USA

- KPMG, Glendale



Gira GmbH & Co. KG, Radevormwald (Location)



Caggemini Sogeti Danmark A/S, Vallensbæk Strand

References

Excerpt



Südwestmetall, Heilbronn (Location)



Zalando SE, Berlin



Public Centre for Social Welfare Arendonk



Cruise Center Steinwerder, Hamburg

References

Excerpt



Agaplesion Diaconical Hospital Hamburg



Public Centre for Social Welfare Arendonk



09/2019 EN Subject to technical modifications / colour variations

Kusch+Co GmbH
P.O. Box 1151
59965 Hallenberg
Germany

T +49 2984 300-0
F +49 2984 3004-100
welcome@kusch.com
kusch.com

KUSCH+CO
by Nowy Styl