

Cloud

Cloud is a true acoustic solution, mainly because of its sheer size. With the addition of LED spotlights it is the perfect model to hang above a large table or a group of desks. In a high hallway or open space this also will be a great design feature.

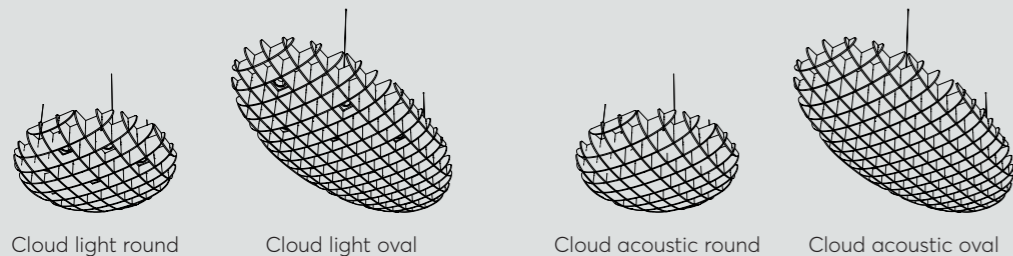



Cloud light round



Material:
 PET Felt (polyethylene terephthalate)
 Fireclass: EN13501-1 Class B-s1-d0
 Produced in The Netherlands

Fixture:
 2m black textile cable
 4 black metal wires with adjustable griplock
 Black ceiling cap

Lighting properties:

Integrated LED
 9x 6W | 9x 400lm

Dimmable
 Trailing edge (RC)

CCT 2700K | 3000K | 4000K

IP20

Acoustic properties:

High absorption value

Diffusion

Measurements:

Total weight: 6,4kg

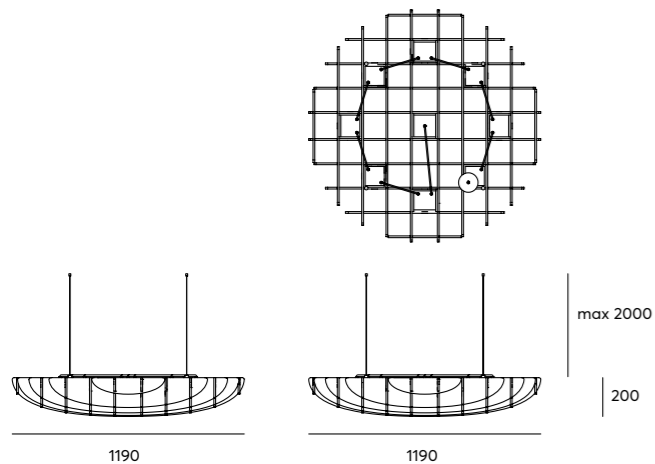

Colours:

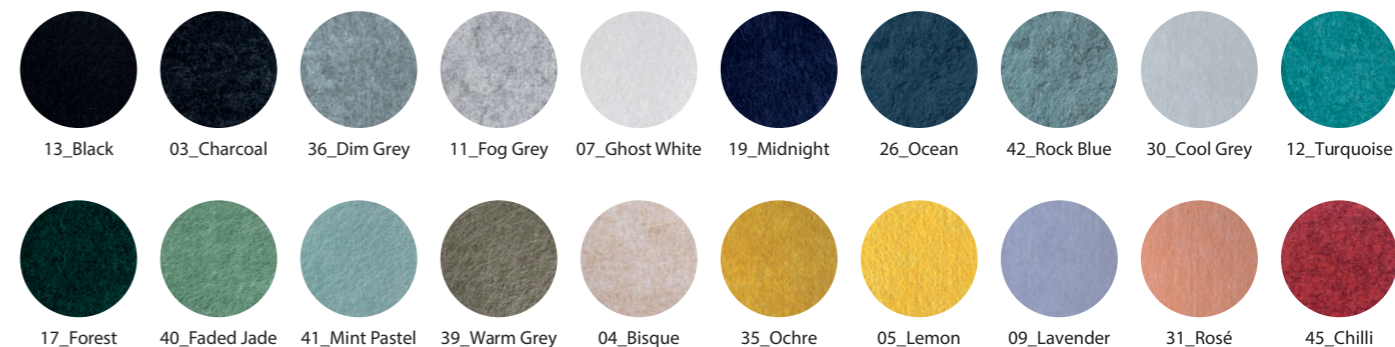

Light source specifications:



LED power:	9x 6W
Connection voltage:	220-240V DC
Luminous Flux:	9x 400lm
Frequency:	47-63Hz
Driver:	Included/Integrated
Control/Dimmable:	Trailing edge (RC)
Power factor:	122lm/W
Beam of light:	40°
CCT Colour temperature:	2700K 3000K 4000K
CRI:	Ra>80
UGR:	<10
Operating temperature:	-20 ~ +40

Acoustic specifications:

Our models are currently being tested for their improved acoustic value

Order code:

é13		Version		PET Felt colour		LED colour		Dimming technology		é13... / ... / ... / ...	
Model	Version	colour	#	2700K	3000K	4000K	1	2	3	dimmable RC (trailing edge)	B
é13	round 01										

For example: é1301/11/2/A
 Cloud light round / Fog Grey / 3000K / not dimmable

Cloud light oval



Cloud light oval

Material:
 PET Felt (polyethylene terephthalate)
 Fireclass: EN13501-1 Class B-s1-d0
 Produced in The Netherlands

Fixture:
 2m black textile cable
 4 black metal wires with adjustable griplock
 Black ceiling cap

Lighting properties:

Integrated LED
 10x 6W | 10x 400lm

Dimmable
 Trailing edge (RC)

CCT
 2700K | 3000K | 4000K

IP20

Acoustic properties:

High absorption value

Diffusion

Measurements:

Total weight: 9,9kg

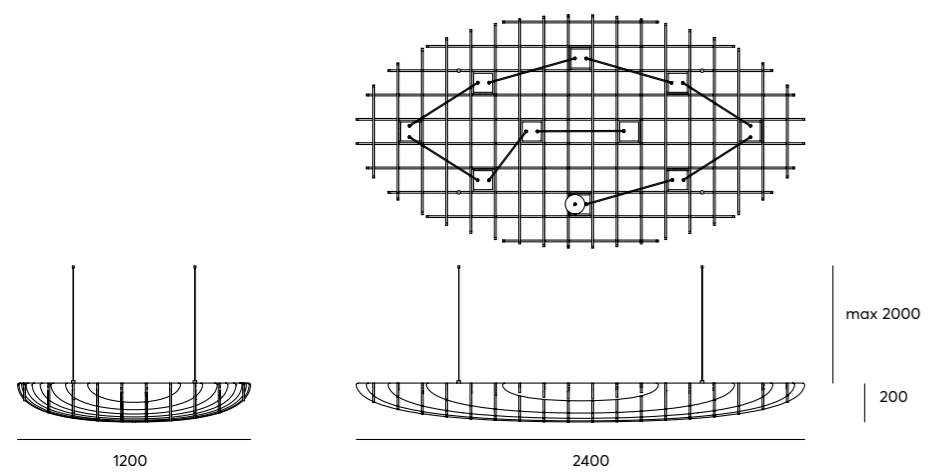

Colours:

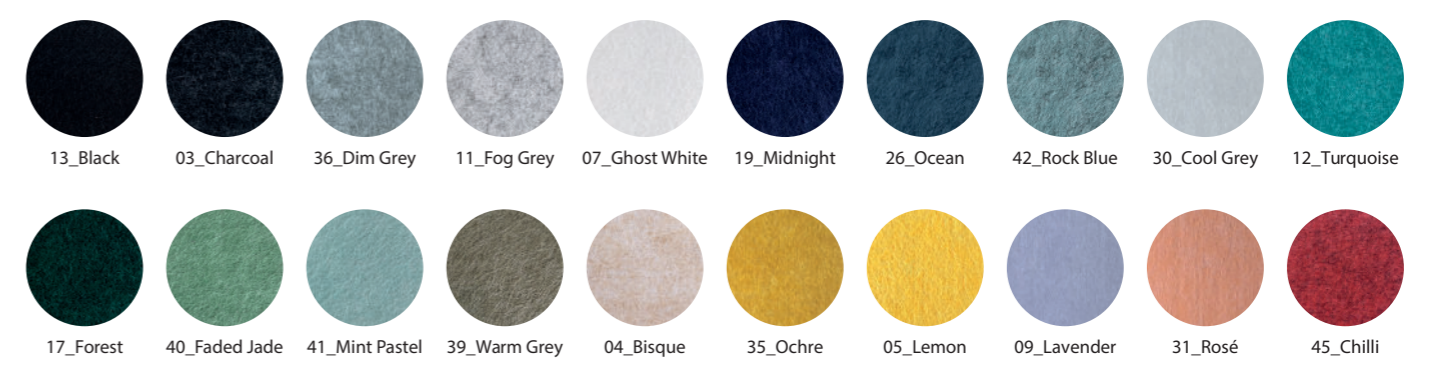

Light source specifications:



LED power:	10x 6W
Connection voltage:	220-240V DC
Luminous Flux:	10x 400lm
Frequency:	47-63Hz
Driver:	Included/Integrated
Control/Dimmable:	Trailing edge (RC)
Power factor:	122lm/W
Beam of light:	40°
CCT Colour temperature:	2700K 3000K 4000K
CRI:	Ra>80
UGR:	<10
Operating temperature:	-20 ~ +40

Acoustic specifications:

Our models are currently being tested for their improved acoustic value

Order code:

é13			é13.... / / /	
Model	Version	PET Felt colour		LED colour		Dimming technology					
é13	oval	02	colour	#	2700K 3000K 4000K	1 2 3	dimmable RC (trailing edge)	B			



For example: é1302/39/2/D
 Cloud light oval / Warm Grey / 3000K / Dali



Material:
 PET Felt (polyethylene terephthalate)
 Fireclass: EN13501-1 Class B-s1-d0
 Produced in The Netherlands

Fixture:
 4 black metal wires with adjustable griplock

Acoustic properties:

-  High absorption value
-  Diffusion

Measurements:

Total weight: 4,0kg / 7,5kg

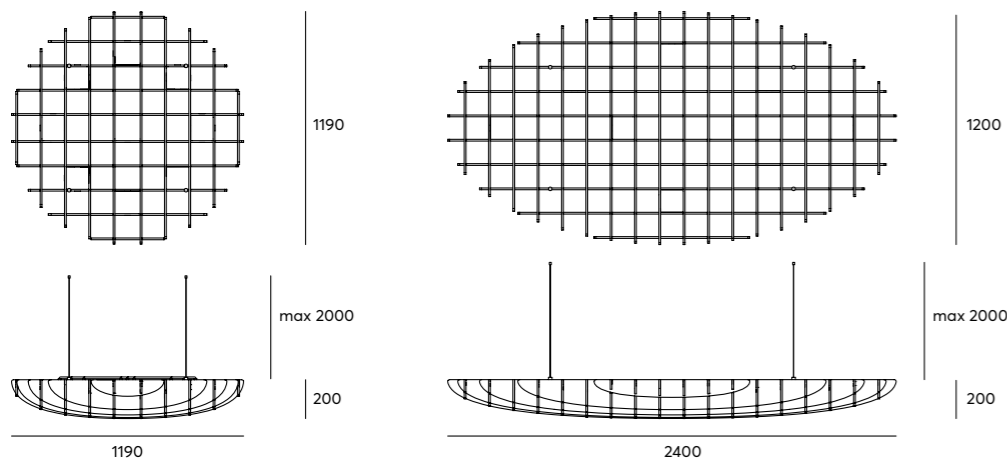

Colours:



Acoustic specifications:

Our models are currently being tested for their improved acoustic value

Order code:

é 14			é 14.... /.....	
Model	Version	PET Felt colour					
é 14	round oval	01 02	colour	#			

For example: é1401/39
 Cloud acoustic round / Warm Grey